

ALLEGATO B

Specifiche tecniche per la fornitura delle Dichiarazioni Precompilate

Schema **fornituraP73_2023_v1.xsd**

schema location: **fornituraP73_2023_v1.xsd**
 attributeFormDefault: **unqualified**
 elementFormDefault: **qualified**
 targetNamespace: **urn:www.agenziaentrate.gov.it:specificheTecniche:sco:p73**

Elements Complex types
[Fornitura](#) [Esito Richiesta Type](#)

schema location: **intestazioneP73_2023_v1.xsd**
 attributeFormDefault: **unqualified**
 elementFormDefault: **qualified**
 targetNamespace: **urn:www.agenziaentrate.gov.it:specificheTecniche:sco:p73**

Complex types
[Intestazione P73 Type](#)

schema location: **documentoP73_2023_v1.xsd**
 attributeFormDefault: **unqualified**
 elementFormDefault: **qualified**
 targetNamespace: **urn:www.agenziaentrate.gov.it:specificheTecniche:sco:p73**

Complex types
[Acconti Altri Dati Type](#)
[Acconti Irpef Anno Imposta Type](#)

[Acconti Ritenute Type](#)
[Acoonti Compensati Intern Type](#)
[Acquisto Costruzione Abit Locazione](#)
[Addizionali Type](#)
[Altre Detrazioni Type](#)
[Altre Ritenute Type](#)
[Altre Spese Type](#)
[Altri Crediti Imposta Type](#)
[Altri Dati Type](#)
[Altri Oneri Type](#)
[Altri Redditi Ass Lav Type](#)
[Altri Redditi Diversi Detr Type](#)
[Altri Redditi Diversi Type](#)
[Altri Redditi Lavoro Autonomo Type](#)
[Altri Redditi Type](#)
[Altri Redditi Utili Type](#)
[Assegno Coniuge Type](#)
[Casella Acconto Type](#)
[Cedolare Secca Type](#)
[Comparto Sicurezza Type](#)
[Conquaglio Type](#)
[Contributi Previdenza Complementare Type](#)
[Contributo Solidarieta Type](#)
[Cred Erogazione Cultura Type](#)
[Cred Imp Estero Type](#)
[Crediti F24 Type](#)

Simple types
[Anno Anticipazione Fondo Pensione Type](#)
[Anno Patrimonio Edilizio Situazioni Particolari Typ](#)
[e](#)
[Anno Recupero Patrimonio Edilizio Type](#)
[Anno Risparmio Energetico Type](#)
[Casella Codice Type](#)
[Casi Particolari Fabbricato Type](#)
[Casi Particolari Risp Ener Type](#)
[Casi Particolari Terreni Type](#)
[Codice Altre Detrazioni Type](#)
[Codice Altre Spese Type](#)
[Codice Altri Oneri Type](#)
[Codice Canone Type](#)
[Codice Evento Eccezionale Type](#)
[Codice Spese Rateizzate Anni Precedenti Type](#)
[Codice Spese Rateizzate Type](#)
[Fabbricato Agev Numero Rigo Type](#)
[Indeterminato Determinato Type](#)
[Mesi Type](#)
[Numero Rata Risparmio Energetico Type](#)
[Numero Rate5o10 Type](#)
[Periodo Spese Ristrutturazione Type](#)
[Rate10 Type](#)
[Rate5 Type](#)
[Rate Risparmio Energetico Type](#)
[Reintegro Totale Parziale Type](#)
[Rideterminazione Rate Type](#)
[Ripart Risparmio Energetico Type](#)
[Serie Registrazione Contratto Type](#)

[Crediti Imposta Altri Sisma Abruzzo Type](#)
[Crediti Imposta Fabbicati Type](#)
[Crediti Imposta Fondi Pensione Type](#)
[Crediti Imposta Redditi Esteri Type](#)
[Crediti Imposta Type](#)
[Credito Ape](#)
[Credito Erogazioni Cultura Type](#)
[Credito Erogazioni Scuola Type](#)
[Credito Immobile Sisma Abruzzo Type](#)
[Credito Negoziazione Type](#)
[Credito Prima Casa U36](#)
[Credito Stato Type](#)
[Credito Type](#)
[Credito Videosorveglianza Type](#)
[Dati 730 Integrativo Type](#)
[Dati Altre Detrazioni Modulo Type](#)
[Dati Altre Detrazioni Type](#)
[Dati Catastali Recupero Patrimonio Edilizio Type](#)
[Dati Catastali Type](#)
[Dati Coniuge Type](#)
[Dati Contabili Type](#)
[Dati Contratto Type](#)
[Dati Familiare Type](#)
[Dati Nascita PF Type](#)
[Dati Primo Figlio Type](#)
[Dati Registrazione Accatastamento Recupero Patrimonio Edilizio Type](#)
[Debito Type](#)
[Deduzioni Modulo Type](#)
[Deduzioni Type](#)
[Detrazione Crediti Type](#)
[Detrazioni Canoni Locazione Type](#)
[Detrazioni Modulo Type](#)
[Detrazioni Type](#)
[Documento P73 Type](#)
[Domanda Accatastamento Type](#)
[Domicilio Fiscale Type](#)
[Eccedenze Oltre Anno Type](#)
[Eccedenze Type](#)
[Elemento Integrativo Type](#)
[Erogazioni Onlus Type](#)
[Esenzione Add Comunale Type](#)
[Esito Liquidazione Type](#)
[Fabbricato Agev Type](#)
[Fabbricato Ord Type](#)
[Familiari Type](#)
[Fondo Pensione Dipendenti Pubblici Type](#)
[Frontespizio 730 Type](#)
[Giorni Percentuale Type](#)

[Terreni Urbano Type](#)
[Tipo Inquilino Type](#)
[Tipo Intervento Type](#)
[Tipo Reddito Da1a12 Type](#)
[Tipo Reddito Da1a3 Type](#)
[Tipo Reddito Da1a4 Type](#)
[Tipo Reddito Da1a6 Type](#)
[Tipo Reddito Da1a8 Type](#)
[Tipo Reddito Da1a9 Type](#)
[Titolo Terreno Type](#)
[Utilizzo Fabbricato Type](#)

[Imposta Lorda Type](#)
[Imposta Netta Type](#)
[Imposte Rimborsate Type](#)
[Incremento Produttività Type](#)
[Inquilini Abitazione Principale Type](#)
[Intervento Recupero Patrimonio Edilizio Type](#)
[Intervento Risparmio Energetico Type](#)
[Iva Acquisto Abitazione Type](#)
[Lavoro Dipendente Type](#)
[Locazioni Brevi Type](#)
[Misura Acconti Type](#)
[Modulo Altri Redditi Type](#)
[Modulo Crediti Imposta Type](#)
[Modulo Credito Negoziazione Type](#)
[Modulo Fabbricato Type](#)
[Modulo Familiari Type](#)
[Modulo Lavoro Dip Type](#)
[Modulo Oneri Type](#)
[Modulo PL Type](#)
[Modulo Terreno Type](#)
[Modulo Ulteriori Dati Type](#)
[N Rate Type](#)
[Oneri Non Abbattuti Type](#)
[Oneri Type](#)
[Opzione Produttività Type](#)
[Periodo Di Lavoro Type](#)
[Premi Risultato Modulo Type](#)
[Premi Risultato Type](#)
[Primo Modulo Acconti Ritenute Type](#)
[Primo Modulo Crediti Imposta Type](#)
[Primo Modulo Familiari Type](#)
[Primo Modulo Lavoro Dip Type](#)
[Primo Modulo Oneri Type](#)
[Primo Modulo PL Type](#)
[Prospetto Liquidazione Type](#)
[Prospetto Type](#)
[Redditi Capitale Type](#)
[Redditi Eredi Legatari Type](#)
[Redditi Fabbricati Type](#)
[Redditi Lavoro Dip Type](#)
[Redditi Ritenute Spese Type](#)
[Redditi Ritenute Type](#)
[Redditi Tassazione Separata Type](#)
[Redditi Terreni Type](#)
[Reddito Campione Franchi Type](#)

[Reddito Campione Type](#)
[Reddito Erede Type](#)
[Residuo Credito Compens Annolmposta Type](#)
[Residuo Credito Compens Type](#)
[Residuo Fabbricati Type](#)
[Residuo Onlus Type](#)
[Restituzione Somme Type](#)
[Riduzione Pressione Type](#)
[Riepilogo Redditi Type](#)
[Ritenute Acconti Sospesi Type](#)
[Ritenute Lavoro Dip Type](#)
[Sezione Altri Redd Type](#)
[Sezione Dati Catastali Recupero Patrimonio Edilizio Type](#)
[Soggetto Fiscale 730 Type](#)
[Soglie Esenzione Type](#)
[Spese Arredo Giovani Coppie Type](#)
[Spese Arredo Type](#)
[Spese Laurea Ricarica Type](#)
[Spese Leasing Type](#)
[Spese Rateizzate Anni Precedenti Type](#)
[Spese Rateizzate Type](#)
[Tassazione Separata Type](#)
[Terreno Type](#)
[Ulteriori Dati Type](#)

schema location: **sintetico730_2023.xsd**
 attributeFormDefault: **unqualified**
 elementFormDefault: **qualified**
 targetNamespace: **urn:www.agenziaentrate.gov.it:specificheTecniche:sco:p73**

Elements	Complex types	Simple types
ElencoFonti	AnagraficaType	DataType
Sintetico730	DatiAnagraficiType	ImportoType
	DettaglioFonteType	
	DettaglioType	
	ElencoFontiType	
	FonteType	

element **Fornitura**

diagram	
children	p73:Intestazione p73:EsitoRichiesta

element **Fornitura/Intestazione**

diagram	
type	p73:Intestazione_P73_Type
children	p73:CodiceFornitura p73:TotaleDocRichiesti p73:TotaleDocForniti p73:TotaleDocScartati p73:TotaleDocNonReperiti

element **Fornitura/EsitoRichiesta**

diagram	
type	p73:Esito_Richiesta_Type
children	p73:CodiceFiscaleRichiesta p73:AnagraficaContribuente p73:DocumentoP73 p73:Sintetico730 p73:Stato

complexType **Esito_Richiesta_Type**

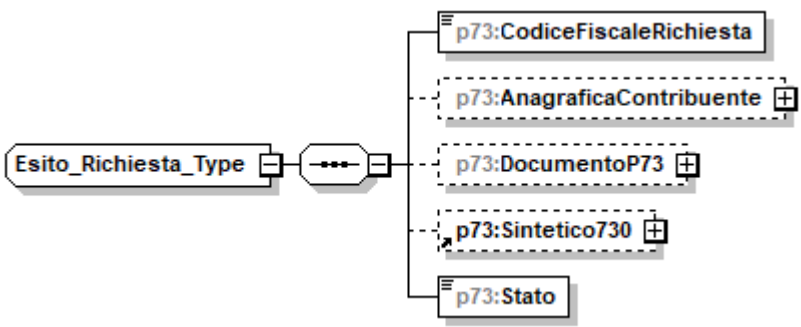
diagram	
children	<p>p73:CodiceFiscaleRichiesta p73:AnagraficaContribuente p73:DocumentoP73 p73:Sintetico730 p73:Stato</p>

element **Esito_Richiesta_Type/CodiceFiscaleRichiesta**

diagram	
---------	---

element **Esito_Richiesta_Type/AnagraficaContribuente**

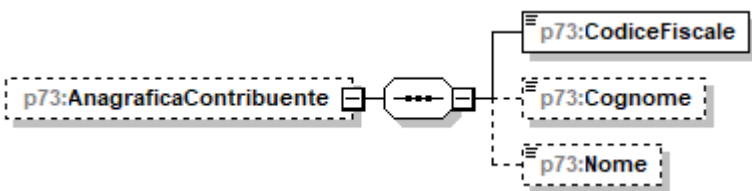
diagram	
children	<p>p73:CodiceFiscale p73:Cognome p73:Nome</p>

element **Esito_Richiesta_Type/AnagraficaContribuente/CodiceFiscale**

diagram	
type	<p>DatoCF_Type</p>

element **Esito_Richiesta_Type/AnagraficaContribuente/Cognome**

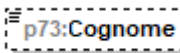
diagram	
type	<p>DatoAN_Type</p>

element **Esito_Richiesta_Type/AnagraficaContribuente/Nome**

diagram	
---------	---

type	DatoAN_Type
------	-----------------------------

element **Esito_Richiesta_Type/DocumentoP73**

diagram	
type	p73:Documento_P73_Type
children	p73:Frontespizio p73:DatiContabili p73:EsitiContabili

element **Esito_Richiesta_Type/Stato**

diagram	
type	DatoAN_Type

complexType **Intestazione_P73_Type**

diagram	
children	p73:CodiceFornitura p73:TotaleDocRichiesti p73:TotaleDocForniti p73:TotaleDocScartati p73:TotaleDocNonReperiti

element **Intestazione_P73_Type/CodiceFornitura**

diagram	
type	restriction of DatoAN_Type

element **Intestazione_P73_Type/TotaleDocRichiesti**

diagram	
type	DatoNP_Type

element **Intestazione_P73_Type/TotaleDocForniti**

diagram	
type	DatoNP_Type

element **Intestazione_P73_Type/TotaleDocScartati**

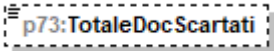
diagram	
type	DatoNP_Type

element **Intestazione_P73_Type/TotaleDocNonReperiti**

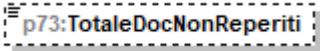
diagram	
type	DatoNP_Type

complexType **Acconti_Altri_Dati_Type**

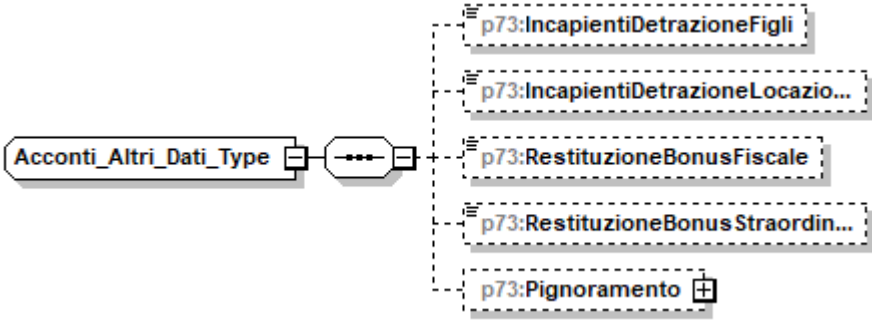
diagram	
children	p73:IncapientiDetrazioneFigli p73:IncapientiDetrazioneLocazione p73:RestituzioneBonusFiscale p73:RestituzioneBonusStraordinario p73:Pignoramento

element **Acconti_Altri_Dati_Type/IncapientiDetrazioneFigli**

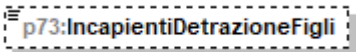
diagram	
type	DatoNP_Type

element **Acconti_Altri_Dati_Type/IncapientiDetrazioneLocazione**

diagram	
type	DatoNP_Type

element **Acconti_Altri_Dati_Type/RestituzioneBonusFiscale**

diagram	
type	DatoNP_Type

element **Acconti_Altri_Dati_Type/RestituzioneBonusStraordinario**

diagram	
type	DatoNP_Type

element **Acconti_Altri_Dati_Type/Pignoramento**

diagram	
children	p73:TipoRedditoPignoramento p73:RitenutePignoramento

element **Acconti_Altri_Dati_Type/Pignoramento/TipoRedditoPignoramento**

diagram															
type	restriction of DatoN1_Type														
facets	<table border="1"> <thead> <tr> <th>Kind</th> <th>Value</th> </tr> </thead> <tbody> <tr> <td>enumeration</td> <td>1</td> </tr> <tr> <td>enumeration</td> <td>2</td> </tr> <tr> <td>enumeration</td> <td>3</td> </tr> <tr> <td>enumeration</td> <td>4</td> </tr> <tr> <td>enumeration</td> <td>5</td> </tr> <tr> <td>enumeration</td> <td>6</td> </tr> </tbody> </table>	Kind	Value	enumeration	1	enumeration	2	enumeration	3	enumeration	4	enumeration	5	enumeration	6
Kind	Value														
enumeration	1														
enumeration	2														
enumeration	3														
enumeration	4														
enumeration	5														
enumeration	6														

element **Acconti_Altri_Dati_Type/Pignoramento/RitenutePignoramento**

diagram	
type	DatoNP_Type

complexType **Acconti_Irpef_Anno_Imposta_Type**

diagram	
children	p73:PrimaRataAccontolrpef p73:SecondaRataAccontolrpef p73:AccontoAddComunale p73:PrimaRataAccontoCedolare p73:SecondaRataAccontoCedolare

element **Acconti_Irpef_Anno_Imposta_Type/PrimaRataAccontolrpef**

diagram	
type	DatoNP_Type

element **Acconti_Irpef_Anno_Imposta_Type/SecondaRataAccontolrpef**

diagram	
type	DatoNP_Type

element **Acconti_Irpef_Anno_Imposta_Type/AccontoAddComunale**

diagram	
type	DatoNP_Type

element **Acconti_Irpef_Anno_Imposta_Type/PrimaRataAccontoCedolare**

diagram	
type	DatoNP_Type

element **Acconti_Irpef_Anno_Imposta_Type/SecondaRataAccontoCedolare**

diagram	
type	DatoNP_Type

complexType **Acconti_Ritenute_Type**

diagram	
children	p73:PrimoModulo p73:Modulo

element **Acconti_Ritenute_Type/PrimoModulo**

diagram	
type	p73:Primo Modulo Acconti Ritenute Type
children	p73:Accontilrpef p73:AltreRitenute p73:Eccedenze p73:EccedenzeOltreAnno p73:RitenuteAccontiSospesi p73:MisuraAcconti p73:EsenzioneAddComunale p73:Dati730Integrativo p73:AccontiAltriDati p73:LocazioniBrevi

element **Acconti_Ritenute_Type/Modulo**

<p>diagram</p>	
<p>children</p>	<p>p73:AltreRitenute p73:EccedenzeOltreAnno p73:Pignoramento</p>

element **Acconti_Ritenute_Type/Modulo/AltreRitenute**

<p>diagram</p>	
<p>type</p>	<p>p73:Altre_Ritenute_Type</p>
<p>children</p>	<p>p73:Codice p73:AltreRitenuteIrpef p73:AddizionaleRegionale p73:AddizionaleComunale p73:AddRegionaleIrpefAttivitaSport p73:AddComunaleIrpefAttivitaSport p73:IrpefLavoriSocialmenteUtili p73:AddRegionaleIrpefLavoriSoc Utili</p>

element **Acconti_Ritenute_Type/Modulo/EccedenzeOltreAnno**

<p>diagram</p>	
<p>type</p>	<p>p73:Eccedenze Oltre Anno Type</p>
<p>children</p>	<p>p73:Anno p73:Irpef p73:SostitutivaQuadroRT p73:CedolareSecca p73:CodiceRegione p73:AddRegionaleIrpef p73:CodiceCatastaleComune p73:AddComunaleIrpef p73:ImpostaSostitutiva</p>

element **Acconti_Ritenute_Type/Modulo/Pignoramento**

<p>diagram</p>	
<p>children</p>	<p>p73:TipoRedditoPignoramento p73:RitenutePignoramento</p>

element **Acconti_Ritenute_Type/Modulo/Pignoramento/TipoRedditoPignoramento**

<p>diagram</p>															
<p>type</p>	<p>restriction of DatoN1_Type</p>														
<p>facets</p>	<table border="1"> <thead> <tr> <th>Kind</th> <th>Value</th> </tr> </thead> <tbody> <tr> <td>enumeration</td> <td>1</td> </tr> <tr> <td>enumeration</td> <td>2</td> </tr> <tr> <td>enumeration</td> <td>3</td> </tr> <tr> <td>enumeration</td> <td>4</td> </tr> <tr> <td>enumeration</td> <td>5</td> </tr> <tr> <td>enumeration</td> <td>6</td> </tr> </tbody> </table>	Kind	Value	enumeration	1	enumeration	2	enumeration	3	enumeration	4	enumeration	5	enumeration	6
Kind	Value														
enumeration	1														
enumeration	2														
enumeration	3														
enumeration	4														
enumeration	5														
enumeration	6														

element **Acconti_Ritenute_Type/Modulo/Pignoramento/RitenutePignoramento**

diagram	
type	DatoNP_Type

complexType **Acconti_Compensati_Intern_Type**

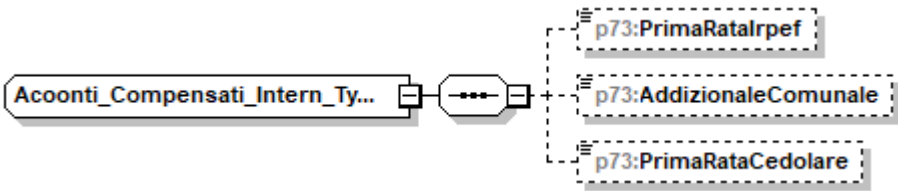
diagram	
children	p73:PrimaRatalrpef p73:AddizionaleComunale p73:PrimaRataCedolare

element **Acconti_Compensati_Intern_Type/PrimaRatalrpef**

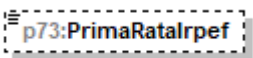
diagram	
type	DatoNP_Type

element **Acconti_Compensati_Intern_Type/AddizionaleComunale**

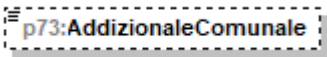
diagram	
type	DatoNP_Type

element **Acconti_Compensati_Intern_Type/PrimaRataCedolare**

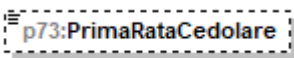
diagram	
type	DatoNP_Type

complexType **Acquisto_Costruzione_Abit_Locazione**

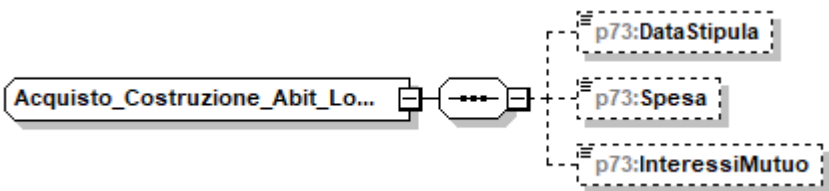
diagram	
children	p73:DataStipula p73:Spesa p73:InteressiMutuo

element **Acquisto_Costruzione_Abit_Locazione/DataStipula**

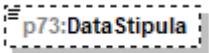
diagram	
type	DatoDT_Type

element **Acquisto_Costruzione_Abit_Locazione/Spesa**

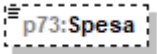
diagram	
type	DatoNP_Type

element **Acquisto_Costruzione_Abit_Locazione/InteressiMutuo**

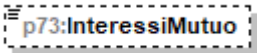
diagram	
type	DatoNP_Type

complexType **Addizionali_Type**

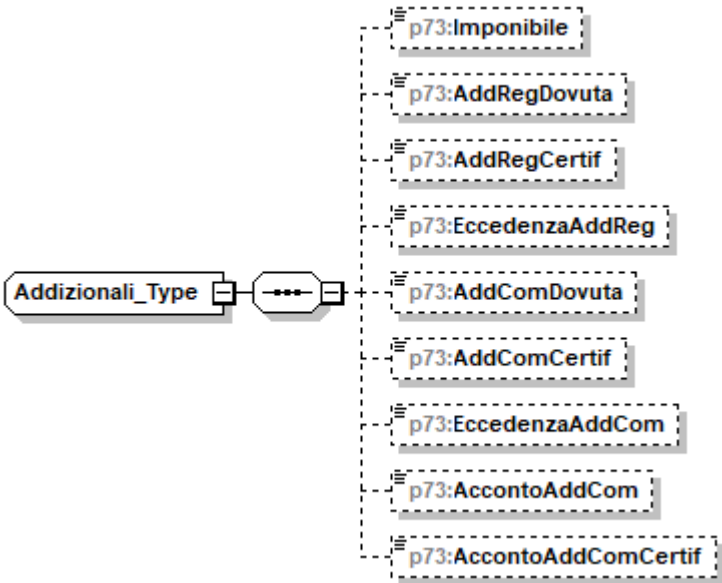
diagram	
children	p73:Imponibile p73:AddRegDovuta p73:AddRegCertif p73:EccedenzaAddReg p73:AddComDovuta p73:AddComCertif p73:EccedenzaAddCom p73:AccontoAddCom p73:AccontoAddComCertif

element **Addizionali_Type/Imponibile**

diagram	
---------	---

type	DatoNP_Type
------	-----------------------------

element **Addizionali_Type/AddRegDovuta**

diagram	
type	DatoNP_Type

element **Addizionali_Type/AddRegCertif**

diagram	
type	DatoNP_Type

element **Addizionali_Type/EccedenzaAddReg**

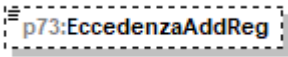
diagram	
type	DatoNU_Type

element **Addizionali_Type/AddComDovuta**

diagram	
type	DatoNP_Type

element **Addizionali_Type/AddComCertif**

diagram	
type	DatoNP_Type

element **Addizionali_Type/EccedenzaAddCom**

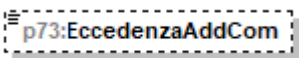
diagram	
type	DatoNU_Type

element **Adizionali_Type/AcontoAddCom**

diagram	
type	DatoNP_Type

element **Adizionali_Type/AcontoAddComCertif**

diagram	
type	DatoNP_Type

complexType **Altre_Detrazioni_Type**

diagram	
children	p73:Codice p73:Importo

element **Altre_Detrazioni_Type/Codice**

diagram											
type	p73:Codice Altre_Detrazioni_Type										
facets	<table border="1"> <thead> <tr> <th>Kind</th> <th>Value</th> </tr> </thead> <tbody> <tr> <td>enumeration</td> <td>1</td> </tr> <tr> <td>enumeration</td> <td>2</td> </tr> <tr> <td>enumeration</td> <td>3</td> </tr> <tr> <td>enumeration</td> <td>4</td> </tr> </tbody> </table>	Kind	Value	enumeration	1	enumeration	2	enumeration	3	enumeration	4
Kind	Value										
enumeration	1										
enumeration	2										
enumeration	3										
enumeration	4										

element **Altre_Detrazioni_Type/Importo**

diagram	
type	DatoNP_Type

complexType **Altre_Ritenute_Type**

<p>diagram</p>	
<p>children</p>	<p>p73:Codice p73:AltreRitenuteIrpef p73:AddizionaleRegionale p73:AddizionaleComunale p73:AddRegionaleIrpefAttivitaSport p73:AddComunaleIrpefAttivitaSport p73:IrpefLavoriSocialmenteUtili p73:AddRegionaleIrpefLavoriSoc Utili</p>

element **Altre_Ritenute_Type/Codice**

<p>diagram</p>							
<p>type</p>	<p>restriction of DatoN1_Type</p>						
<p>facets</p>	<table border="1"> <thead> <tr> <th>Kind</th> <th>Value</th> </tr> </thead> <tbody> <tr> <td>enumeration</td> <td>1</td> </tr> <tr> <td>enumeration</td> <td>2</td> </tr> </tbody> </table>	Kind	Value	enumeration	1	enumeration	2
Kind	Value						
enumeration	1						
enumeration	2						

element **Altre_Ritenute_Type/AltreRitenuteIrpef**

<p>diagram</p>	
<p>type</p>	<p>DatoNP_Type</p>

element **Altre_Ritenute_Type/AddizionaleRegionale**

<p>diagram</p>	
<p>type</p>	<p>DatoNP_Type</p>

element **Altre_Ritenute_Type/AddizionaleComunale**

<p>diagram</p>	
----------------	--

type	DatoNP_Type
------	-----------------------------

element **Altre_Ritenute_Type/AddRegionaleIrpefAttivitaSport**

diagram	
type	DatoNP_Type

element **Altre_Ritenute_Type/AddComunaleIrpefAttivitaSport**

diagram	
type	DatoNP_Type

element **Altre_Ritenute_Type/IrpefLavoriSocialmenteUtili**

diagram	
type	DatoNP_Type

element **Altre_Ritenute_Type/AddRegionaleIrpefLavoriSoc_Utili**

diagram	
type	DatoNP_Type

complexType **Altre_Spese_Type**

diagram	
children	p73:Codice p73:Importo

element **Altre_Spese_Type/Codice**

diagram											
type	p73:Codice_Altre_Spese_Type										
facets	<table border="1"> <thead> <tr> <th>Kind</th> <th>Value</th> </tr> </thead> <tbody> <tr> <td>enumeration</td> <td>8</td> </tr> <tr> <td>enumeration</td> <td>9</td> </tr> <tr> <td>enumeration</td> <td>10</td> </tr> <tr> <td>enumeration</td> <td>11</td> </tr> </tbody> </table>	Kind	Value	enumeration	8	enumeration	9	enumeration	10	enumeration	11
Kind	Value										
enumeration	8										
enumeration	9										
enumeration	10										
enumeration	11										

enumeration	12
enumeration	13
enumeration	14
enumeration	15
enumeration	16
enumeration	17
enumeration	18
enumeration	20
enumeration	21
enumeration	22
enumeration	24
enumeration	25
enumeration	26
enumeration	27
enumeration	28
enumeration	29
enumeration	30
enumeration	31
enumeration	32
enumeration	33
enumeration	35
enumeration	36
enumeration	38
enumeration	39
enumeration	40
enumeration	43
enumeration	44
enumeration	45
enumeration	46
enumeration	47
enumeration	61
enumeration	62
enumeration	71
enumeration	76
enumeration	81
enumeration	99

element **Altre_Spese_Type/Importo**

diagram	
type	DatoNP_Type

complexType **Altri_Crediti_Imposta_Type**

diagram	
children	p73:Codice p73:Importo p73:ResiduoAnnoPrec p73:RataDueAnniPrec p73:DiCuiCompensatoF24

element **Altri_Crediti_Imposta_Type/Codice**

diagram	
type	restriction of DatoNP_Type

element **Altri_Crediti_Imposta_Type/Importo**

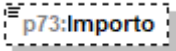
diagram	
type	restriction of DatoNP_Type

element **Altri_Crediti_Imposta_Type/ResiduoAnnoPrec**

diagram	
type	restriction of DatoNP_Type

element **Altri_Crediti_Imposta_Type/RataDueAnniPrec**

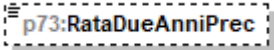
diagram	
type	restriction of DatoNP_Type

element **Altri_Crediti_Imposta_Type/DiCuiCompensatoF24**

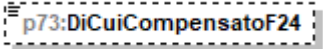
diagram	
type	restriction of DatoNP_Type

complexType **Altri_Dati_Type**

diagram	
---------	---

complexType **Altri_Oneri_Type**

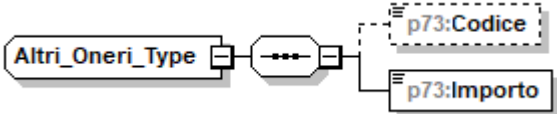
diagram	
children	p73:Codice p73:Importo

element **Altri_Oneri_Type/Codice**

diagram																	
type	p73:Codice Altri Oneri Type																
facets	<table border="1"> <thead> <tr> <th>Kind</th> <th>Value</th> </tr> </thead> <tbody> <tr> <td>enumeration</td> <td>6</td> </tr> <tr> <td>enumeration</td> <td>7</td> </tr> <tr> <td>enumeration</td> <td>8</td> </tr> <tr> <td>enumeration</td> <td>9</td> </tr> <tr> <td>enumeration</td> <td>12</td> </tr> <tr> <td>enumeration</td> <td>13</td> </tr> <tr> <td>enumeration</td> <td>21</td> </tr> </tbody> </table>	Kind	Value	enumeration	6	enumeration	7	enumeration	8	enumeration	9	enumeration	12	enumeration	13	enumeration	21
Kind	Value																
enumeration	6																
enumeration	7																
enumeration	8																
enumeration	9																
enumeration	12																
enumeration	13																
enumeration	21																

element **Altri_Oneri_Type/Importo**

diagram	
type	DatoNP_Type

complexType **Altri_Redditi_Ass_Lav_Type**

diagram	
children	p73:AssegnoDelConiuge p73:ImportoRedditoAssimilato p73:AltriDati

element **Altri_Redditi_Ass_Lav_Type/AssegnoDelConiuge**

diagram	
type	DatoCB_Type

element **Altri_Redditi_Ass_Lav_Type/ImportoRedditoAssimilato**

diagram	
type	DatoNP_Type

element **Altri_Reddito_Ass_Lav_Type/AltriDati**

diagram							
type	restriction of DatoNP_Type						
facets	<table border="1"> <thead> <tr> <th>Kind</th> <th>Value</th> </tr> </thead> <tbody> <tr> <td>enumeration</td> <td>1</td> </tr> <tr> <td>enumeration</td> <td>5</td> </tr> </tbody> </table>	Kind	Value	enumeration	1	enumeration	5
Kind	Value						
enumeration	1						
enumeration	5						

complexType **Altri_Reddito_Diversi_Detr_Type**

diagram	
children	p73:AltriDati p73:Tipo_Reddito p73:RedditiRitenuteSpese

element **Altri_Reddito_Diversi_Detr_Type/AltriDati**

diagram					
type	restriction of DatoNP_Type				
facets	<table border="1"> <thead> <tr> <th>Kind</th> <th>Value</th> </tr> </thead> <tbody> <tr> <td>enumeration</td> <td>5</td> </tr> </tbody> </table>	Kind	Value	enumeration	5
Kind	Value				
enumeration	5				

element **Altri_Reddito_Diversi_Detr_Type/Tipo_Reddito**

diagram													
type	restriction of DatoNP_Type												
facets	<table border="1"> <thead> <tr> <th>Kind</th> <th>Value</th> </tr> </thead> <tbody> <tr> <td>enumeration</td> <td>1</td> </tr> <tr> <td>enumeration</td> <td>2</td> </tr> <tr> <td>enumeration</td> <td>3</td> </tr> <tr> <td>enumeration</td> <td>4</td> </tr> <tr> <td>enumeration</td> <td>5</td> </tr> </tbody> </table>	Kind	Value	enumeration	1	enumeration	2	enumeration	3	enumeration	4	enumeration	5
Kind	Value												
enumeration	1												
enumeration	2												
enumeration	3												
enumeration	4												
enumeration	5												

element **Altri_Reddito_Diversi_Detr_Type/RedditoRitenuteSpese**

diagram	
type	p73:Reddito Ritenute Spese Type
children	p73:ImportoReddito p73:ImportoRitenute p73:ImportoSpese

complexType **Altri_Reddito_Diversi_Type**

diagram	
children	p73:CedolareSecca p73:TipoReddito p73:RedditoRitenuteSpese

element **Altri_Reddito_Diversi_Type/CedolareSecca**

diagram	
type	DatoCB Type

element **Altri_Reddito_Diversi_Type/TipoReddito**

diagram																									
type	restriction of DatoNP Type																								
facets	<table border="1"> <thead> <tr> <th>Kind</th> <th>Value</th> </tr> </thead> <tbody> <tr><td>enumeration</td><td>1</td></tr> <tr><td>enumeration</td><td>2</td></tr> <tr><td>enumeration</td><td>3</td></tr> <tr><td>enumeration</td><td>4</td></tr> <tr><td>enumeration</td><td>5</td></tr> <tr><td>enumeration</td><td>6</td></tr> <tr><td>enumeration</td><td>7</td></tr> <tr><td>enumeration</td><td>8</td></tr> <tr><td>enumeration</td><td>9</td></tr> <tr><td>enumeration</td><td>10</td></tr> <tr><td>enumeration</td><td>11</td></tr> </tbody> </table>	Kind	Value	enumeration	1	enumeration	2	enumeration	3	enumeration	4	enumeration	5	enumeration	6	enumeration	7	enumeration	8	enumeration	9	enumeration	10	enumeration	11
Kind	Value																								
enumeration	1																								
enumeration	2																								
enumeration	3																								
enumeration	4																								
enumeration	5																								
enumeration	6																								
enumeration	7																								
enumeration	8																								
enumeration	9																								
enumeration	10																								
enumeration	11																								

element **Altri_Reddito_Diversi_Type/RedditoRitenuteSpese**

diagram	
type	p73:RedditoRitenuteSpese_Type
children	p73:ImportoReddito p73:ImportoRitenute p73:ImportoSpese

complexType **Altri_Reddito_Lavoro_Autonomo_Type**

diagram	
children	p73:AltriDati p73:TipoReddito p73:RedditoRitenute

element **Altri_Reddito_Lavoro_Autonomo_Type/AltriDati**

diagram					
type	restriction of DatoNP_Type				
facets	<table border="1"> <thead> <tr> <th>Kind</th> <th>Value</th> </tr> </thead> <tbody> <tr> <td>enumeration</td> <td>5</td> </tr> </tbody> </table>	Kind	Value	enumeration	5
Kind	Value				
enumeration	5				

element **Altri_Reddito_Lavoro_Autonomo_Type/TipoReddito**

diagram									
type	p73:TipoRedditoDa1a3_Type								
facets	<table border="1"> <thead> <tr> <th>Kind</th> <th>Value</th> </tr> </thead> <tbody> <tr> <td>enumeration</td> <td>1</td> </tr> <tr> <td>enumeration</td> <td>2</td> </tr> <tr> <td>enumeration</td> <td>3</td> </tr> </tbody> </table>	Kind	Value	enumeration	1	enumeration	2	enumeration	3
Kind	Value								
enumeration	1								
enumeration	2								
enumeration	3								

element **Altri_Reddito_Lavoro_Autonomo_Type/RedditiRitenute**

diagram	
type	p73:Redditi_Ritenute_Type
children	p73:ImportoRedditi p73:ImportoRitenute

complexType **Altri_Reddito_Type**

diagram	
children	p73:Modulo

element **Altri_Reddito_Type/Modulo**

diagram	
type	p73:Modulo_Altri_Reddito_Type
children	p73:RedditiDiCapitale p73:RedditiTassazioneSeparata

complexType **Altri_Reddito_Utili_Type**

diagram	
children	p73:Tipo_Reddito p73:RedditiRitenute

element **Altri_Reddito_Utili_Type/Tipo_Reddito**

diagram					
type	restriction of DatoNP_Type				
facets	<table border="1"> <thead> <tr> <th>Kind</th> <th>Value</th> </tr> </thead> <tbody> <tr> <td>enumeration</td> <td>1</td> </tr> </tbody> </table>	Kind	Value	enumeration	1
Kind	Value				
enumeration	1				

	enumeration 2
	enumeration 3
	enumeration 4
	enumeration 5
	enumeration 6
	enumeration 7
	enumeration 8
	enumeration 9
	enumeration 10
	enumeration 11

element **Altri_Reddito_Utili_Type/RedditiRitenute**

diagram	
type	p73:Redditi_Ritenute_Type
children	p73:ImportoRedditi p73:ImportoRitenute

complexType **Assegno_Coniuge_Type**

diagram	
children	p73:CodiceFiscale p73:Importo

element **Assegno_Coniuge_Type/CodiceFiscale**

diagram	
type	DatoCF_Type

element **Assegno_Coniuge_Type/Importo**

diagram	
type	DatoNP_Type

complexType Casella_Acconto_Type

diagram	
children	p73:Casella p73:ImportoMisuralInferiore

element Casella_Acconto_Type/Casella

diagram	
type	DatoCB_Type

element Casella_Acconto_Type/ImportoMisuralInferiore

diagram	
type	DatoNP_Type

complexType Cedolare_Secca_Type

diagram	
children	p73:CedolareDovuta p73:EccedenzaCedolareSecca p73:AccontoCedolare

element Cedolare_Secca_Type/CedolareDovuta

diagram	
type	DatoNP_Type

element Cedolare_Secca_Type/EccedenzaCedolareSecca

diagram	
type	DatoNU_Type

element **Cedolare_Secca_Type/AcontoCedolare**

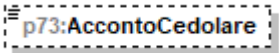
diagram	
type	DatoNP_Type

complexType **Comparto_Sicurezza_Type**

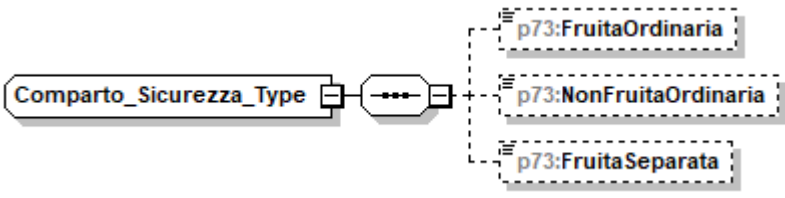
diagram	
children	p73:FruitaOrdinaria p73:NonFruitaOrdinaria p73:FruitaSeparata

element **Comparto_Sicurezza_Type/FruitaOrdinaria**

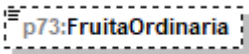
diagram	
type	DatoNP_Type

element **Comparto_Sicurezza_Type/NonFruitaOrdinaria**

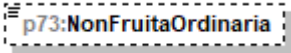
diagram	
type	DatoNP_Type

element **Comparto_Sicurezza_Type/FruitaSeparata**

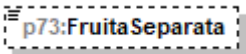
diagram	
type	DatoNP_Type

complexType **Conguaglio_Type**

<p>diagram</p>	
<p>children</p>	<p>p73:NumeroRate p73:ImportoTrattenutoSaldo p73:ImportoTrattenutoAcconto p73:ImportoDaVersareF24Saldo p73:ImportoDaVersareF24Acconto p73:ImportoRimborsato p73:ImportoRimborsatoAgenzia p73:OpzioneInformativa</p>

element **Conguaglio_Type/NumeroRate**

<p>diagram</p>															
<p>type</p>	<p>restriction of DatoN1_Type</p>														
<p>facets</p>	<table border="1"> <thead> <tr> <th>Kind</th> <th>Value</th> </tr> </thead> <tbody> <tr> <td>enumeration</td> <td>2</td> </tr> <tr> <td>enumeration</td> <td>3</td> </tr> <tr> <td>enumeration</td> <td>4</td> </tr> <tr> <td>enumeration</td> <td>5</td> </tr> <tr> <td>enumeration</td> <td>6</td> </tr> <tr> <td>enumeration</td> <td>7</td> </tr> </tbody> </table>	Kind	Value	enumeration	2	enumeration	3	enumeration	4	enumeration	5	enumeration	6	enumeration	7
Kind	Value														
enumeration	2														
enumeration	3														
enumeration	4														
enumeration	5														
enumeration	6														
enumeration	7														

element **Conguaglio_Type/ImportoTrattenutoSaldo**

<p>diagram</p>	
<p>type</p>	<p>DatoNP_Type</p>

element **Conguaglio_Type/ImportoTrattenutoAcconto**

<p>diagram</p>	
<p>type</p>	<p>DatoNP_Type</p>

element **Conguaglio_Type/ImportoDaVersareF24Saldo**

diagram	
type	DatoNP_Type

element **Conguaglio_Type/ImportoDaVersareF24Acconto**

diagram	
type	DatoNP_Type

element **Conguaglio_Type/ImportoRimborsato**

diagram	
type	DatoNP_Type

element **Conguaglio_Type/ImportoRimborsatoAgenzia**

diagram	
type	DatoNP_Type

element **Conguaglio_Type/OpzioneInformativa**

diagram	
type	DatoCB_Type

complexType **Contributi_Previdenza_Complementare_Type**

diagram	
children	p73:EsclusiDalSostituto p73:NonEsclusiDalSostituto

element **Contributi_Previdenza_Complementare_Type/EsclusiDalSostituto**

diagram	
type	DatoNP_Type

element **Contributi_Previdenza_Complementare_Type/NonEsclusiDalSostituto**

diagram	
type	DatoNP_Type

complexType **Contributo_Solidarieta_Type**

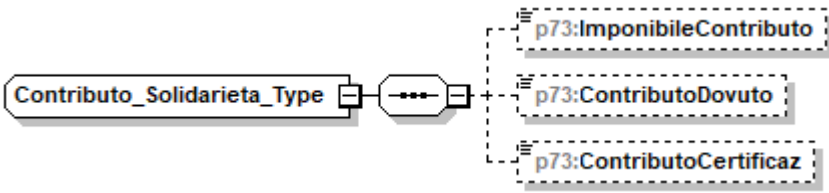
diagram	
children	p73:ImponibileContributo p73:ContributoDovuto p73:ContributoCertificaz

element **Contributo_Solidarieta_Type/ImponibileContributo**

diagram	
type	DatoNP_Type

element **Contributo_Solidarieta_Type/ContributoDovuto**

diagram	
type	DatoNP_Type

element **Contributo_Solidarieta_Type/ContributoCertificaz**

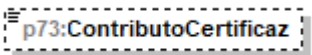
diagram	
type	DatoNP_Type

complexType **Cred_Erogazione_Cultura_Type**

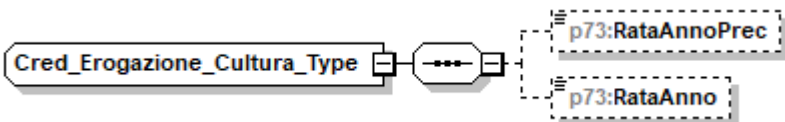
diagram	
children	p73:RataAnnoPrec p73:RataAnno

element **Cred_Erogazione_Cultura_Type/RataAnnoPrec**

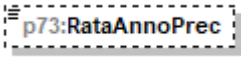
diagram	
type	DatoNP_Type

element **Cred_Erogazione_Cultura_Type/RataAnno**

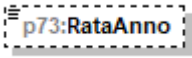
diagram	
type	DatoNP_Type

complexType **Cred_Imp_Estero_Type**

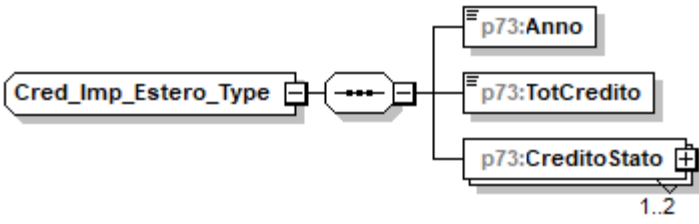
diagram	
children	p73:Anno p73:TotCredito p73:CreditoStato

element **Cred_Imp_Estero_Type/Anno**

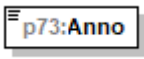
diagram	
type	DatoDA_Type

element **Cred_Imp_Estero_Type/TotCredito**

diagram	
type	DatoNP_Type

element **Cred_Imp_Estero_Type/CreditoStato**

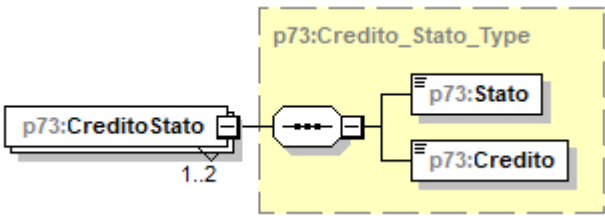
diagram	
---------	---

type	p73:Credito Stato Type
children	p73:Stato p73:Credito

complexType **Crediti_F24_Type**

diagram	
children	p73:Credlrpef p73:CredlrpefDipNoSostituto p73:CodAddReg p73:CredAddReg p73:CredAddRegDipNoSostituto p73:CodiceAddCom p73:CredAddCom p73:CredAddComDipNoSostituto p73:CredCedolare p73:CredCedolareDipNoSostituto p73:CredTassSeparDipNoSostitu... p73:CredImpostaSostDipNoSost... p73:Totale p73:TotaleDipNoSostituto

element **Crediti_F24_Type/Credlrpef**

diagram	
type	DatoNP_Type

element **Crediti_F24_Type/CredlrpefDipNoSostituto**

diagram	
type	DatoNP_Type

element **Crediti_F24_Type/CodAddReg**

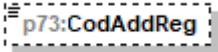
diagram																																													
type	Codice Regione_Type																																												
facets	<table border="1"> <thead> <tr> <th>Kind</th> <th>Value</th> </tr> </thead> <tbody> <tr><td>enumeration</td><td>1</td></tr> <tr><td>enumeration</td><td>2</td></tr> <tr><td>enumeration</td><td>3</td></tr> <tr><td>enumeration</td><td>4</td></tr> <tr><td>enumeration</td><td>5</td></tr> <tr><td>enumeration</td><td>6</td></tr> <tr><td>enumeration</td><td>7</td></tr> <tr><td>enumeration</td><td>8</td></tr> <tr><td>enumeration</td><td>9</td></tr> <tr><td>enumeration</td><td>10</td></tr> <tr><td>enumeration</td><td>11</td></tr> <tr><td>enumeration</td><td>12</td></tr> <tr><td>enumeration</td><td>13</td></tr> <tr><td>enumeration</td><td>14</td></tr> <tr><td>enumeration</td><td>15</td></tr> <tr><td>enumeration</td><td>16</td></tr> <tr><td>enumeration</td><td>17</td></tr> <tr><td>enumeration</td><td>18</td></tr> <tr><td>enumeration</td><td>19</td></tr> <tr><td>enumeration</td><td>20</td></tr> <tr><td>enumeration</td><td>21</td></tr> </tbody> </table>	Kind	Value	enumeration	1	enumeration	2	enumeration	3	enumeration	4	enumeration	5	enumeration	6	enumeration	7	enumeration	8	enumeration	9	enumeration	10	enumeration	11	enumeration	12	enumeration	13	enumeration	14	enumeration	15	enumeration	16	enumeration	17	enumeration	18	enumeration	19	enumeration	20	enumeration	21
Kind	Value																																												
enumeration	1																																												
enumeration	2																																												
enumeration	3																																												
enumeration	4																																												
enumeration	5																																												
enumeration	6																																												
enumeration	7																																												
enumeration	8																																												
enumeration	9																																												
enumeration	10																																												
enumeration	11																																												
enumeration	12																																												
enumeration	13																																												
enumeration	14																																												
enumeration	15																																												
enumeration	16																																												
enumeration	17																																												
enumeration	18																																												
enumeration	19																																												
enumeration	20																																												
enumeration	21																																												

element **Crediti_F24_Type/CredAddReg**

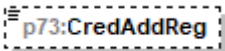
diagram	
type	DatoNP_Type

element **Crediti_F24_Type/CredAddRegDipNoSostituto**

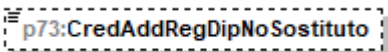
diagram	
type	DatoNP_Type

element **Crediti_F24_Type/CodiceAddCom**

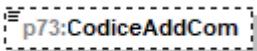
diagram	
type	DatoAN_Type

element **Crediti_F24_Type/CredAddCom**

diagram	
type	DatoNP_Type

element **Crediti_F24_Type/CredAddComDipNoSostituto**

diagram	
type	DatoNP_Type

element **Crediti_F24_Type/CredCedolare**

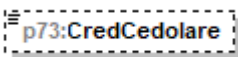
diagram	
type	DatoNP_Type

element **Crediti_F24_Type/CredCedolareDipNoSostituto**

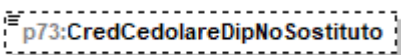
diagram	
type	DatoNP_Type

element **Crediti_F24_Type/CredTassSeparDipNoSostituto**

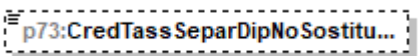
diagram	
type	DatoNP_Type

element **Crediti_F24_Type/CredImpostaSostDipNoSostituto**

diagram	
type	DatoNP_Type

element **Crediti_F24_Type/Totale**

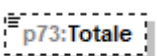
diagram	
---------	---

type	DatoNP_Type
------	-----------------------------

element **Crediti_F24_Type/TotaleDipNoSostituto**

diagram	
type	DatoNP_Type

complexType **Crediti_Imposta_Altri_Sisma_Abruzzo_Type**

diagram	
children	p73:Impresa_Professione p73:CodiceFiscale p73:NumeroRata p73:TotaleCredito p73:Rateazione

element **Crediti_Imposta_Altri_Sisma_Abruzzo_Type/Impresa_Professione**

diagram	
type	DatoCB_Type

element **Crediti_Imposta_Altri_Sisma_Abruzzo_Type/CodiceFiscale**

diagram	
type	DatoCF_Type

element **Crediti_Imposta_Altri_Sisma_Abruzzo_Type/NumeroRata**

diagram													
type	restriction of DatoNP_Type												
facets	<table border="1"> <thead> <tr> <th>Kind</th> <th>Value</th> </tr> </thead> <tbody> <tr> <td>enumeration</td> <td>1</td> </tr> <tr> <td>enumeration</td> <td>2</td> </tr> <tr> <td>enumeration</td> <td>3</td> </tr> <tr> <td>enumeration</td> <td>4</td> </tr> <tr> <td>enumeration</td> <td>5</td> </tr> </tbody> </table>	Kind	Value	enumeration	1	enumeration	2	enumeration	3	enumeration	4	enumeration	5
Kind	Value												
enumeration	1												
enumeration	2												
enumeration	3												
enumeration	4												
enumeration	5												

enumeration	6
enumeration	7
enumeration	8
enumeration	9
enumeration	10

element **Crediti_Imposta_Altri_Sisma_Abruzzo_Type/TotaleCredito**

diagram	
type	DatoNP_Type

element **Crediti_Imposta_Altri_Sisma_Abruzzo_Type/Rateazione**

diagram							
type	restriction of DatoNP_Type						
facets	<table border="1"> <thead> <tr> <th>Kind</th> <th>Value</th> </tr> </thead> <tbody> <tr> <td>enumeration</td> <td>5</td> </tr> <tr> <td>enumeration</td> <td>10</td> </tr> </tbody> </table>	Kind	Value	enumeration	5	enumeration	10
Kind	Value						
enumeration	5						
enumeration	10						

complexType **Crediti_Imposta_Fabbicati_Type**

diagram	
children	p73:ResiduoFabbicati p73:CanoniLocazioneNonPercepiti

element **Crediti_Imposta_Fabbicati_Type/ResiduoFabbicati**

diagram	
type	p73:Residuo_Fabbicati_Type
children	p73:ResiduoPrecedenteDichiarazione p73:CreditoAnno p73:DiCuiCompensatoF24

element **Crediti_Imposta_Fabbicati_Type/CanoniLocazioneNonPerceptiti**

diagram	
type	DatoNP_Type

complexType **Crediti_Imposta_Fondi_Pensione_Type**

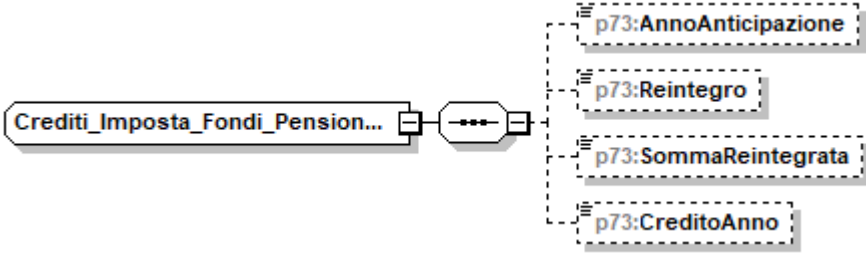
diagram	
children	p73:AnnoAnticipazione p73:Reintegro p73:SommaReintegrata p73:CreditoAnno

element **Crediti_Imposta_Fondi_Pensione_Type/AnnoAnticipazione**

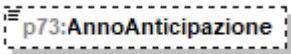
diagram																																			
type	p73:Anno_Anticipazione_Fondo_Pensione_Type																																		
facets	<table border="1"> <thead> <tr> <th>Kind</th> <th>Value</th> </tr> </thead> <tbody> <tr><td>enumeration</td><td>2007</td></tr> <tr><td>enumeration</td><td>2008</td></tr> <tr><td>enumeration</td><td>2009</td></tr> <tr><td>enumeration</td><td>2010</td></tr> <tr><td>enumeration</td><td>2011</td></tr> <tr><td>enumeration</td><td>2012</td></tr> <tr><td>enumeration</td><td>2013</td></tr> <tr><td>enumeration</td><td>2014</td></tr> <tr><td>enumeration</td><td>2015</td></tr> <tr><td>enumeration</td><td>2016</td></tr> <tr><td>enumeration</td><td>2017</td></tr> <tr><td>enumeration</td><td>2018</td></tr> <tr><td>enumeration</td><td>2019</td></tr> <tr><td>enumeration</td><td>2020</td></tr> <tr><td>enumeration</td><td>2021</td></tr> <tr><td>enumeration</td><td>2022</td></tr> </tbody> </table>	Kind	Value	enumeration	2007	enumeration	2008	enumeration	2009	enumeration	2010	enumeration	2011	enumeration	2012	enumeration	2013	enumeration	2014	enumeration	2015	enumeration	2016	enumeration	2017	enumeration	2018	enumeration	2019	enumeration	2020	enumeration	2021	enumeration	2022
Kind	Value																																		
enumeration	2007																																		
enumeration	2008																																		
enumeration	2009																																		
enumeration	2010																																		
enumeration	2011																																		
enumeration	2012																																		
enumeration	2013																																		
enumeration	2014																																		
enumeration	2015																																		
enumeration	2016																																		
enumeration	2017																																		
enumeration	2018																																		
enumeration	2019																																		
enumeration	2020																																		
enumeration	2021																																		
enumeration	2022																																		

element **Crediti_Imposta_Fondi_Pensione_Type/Reintegro**

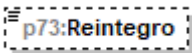
diagram							
type	p73:Reintegro_Totale_Parziale_Type						
facets	<table border="1"> <thead> <tr> <th>Kind</th> <th>Value</th> </tr> </thead> <tbody> <tr><td>enumeration</td><td>1</td></tr> <tr><td>enumeration</td><td>2</td></tr> </tbody> </table>	Kind	Value	enumeration	1	enumeration	2
Kind	Value						
enumeration	1						
enumeration	2						

element **Crediti_Imposta_Fondi_Pensione_Type/SommaReintegrata**

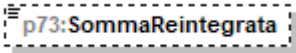
diagram	
type	DatoNP_Type

element **Crediti_Imposta_Fondi_Pensione_Type/CreditoAnno**

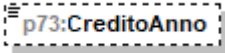
diagram	
type	DatoNP_Type

complexType **Crediti_Imposta_Redditi_Esteri_Type**

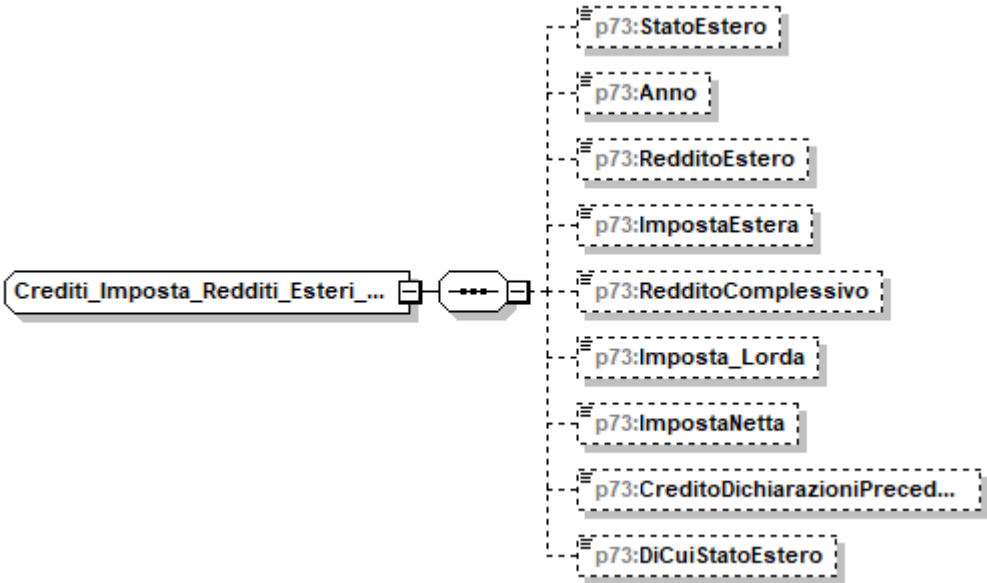
diagram	
children	p73:StatoEstero p73:Anno p73:RedditoEstero p73:ImpostaEstera p73:RedditoComplessivo p73:Imposta_Lorda p73:ImpostaNetta p73:CreditoDichiarazioniPrecedenti p73:DiCuiStatoEstero

element **Crediti_Imposta_Redditi_Esteri_Type/StatoEstero**

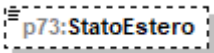
diagram	
type	DatoAN_Type

element **Crediti_Imposta_Redditi_Esteri_Type/Anno**

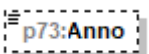
diagram	
type	restriction of DatoDA_Type

element **Crediti_Imposta_Redditi_Esteri_Type/RedditoEstero**

diagram	
type	DatoNP_Type

element **Crediti_Imposta_Redditi_Esteri_Type/ImpostaEstera**

diagram	
type	DatoNP_Type

element **Crediti_Imposta_Redditi_Esteri_Type/RedditoComplessivo**

diagram	
type	DatoNP_Type

element **Crediti_Imposta_Redditi_Esteri_Type/Imposta_Lorda**

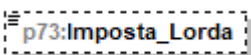
diagram	
type	DatoNP_Type

element **Crediti_Imposta_Redditi_Esteri_Type/ImpostaNetta**

diagram	
type	DatoNP_Type

element **Crediti_Imposta_Redditi_Esteri_Type/CreditoDichiarazioniPrecedenti**

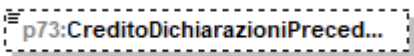
diagram	
type	DatoNP_Type

element **Crediti_Imposta_Redditi_Esteri_Type/DiCuiStatoEstero**

diagram	
---------	---

type	DatoNP_Type
------	-----------------------------

complexType **Crediti_Imposta_Type**

diagram	
children	p73:PrimoModulo p73:Modulo

element **Crediti_Imposta_Type/PrimoModulo**

diagram	
type	p73:Primo Modulo Crediti Imposta Type
children	p73:CreditiImpostaFabbricati p73:CreditiImpostaFondiPensione p73:CreditiImpostaRedditiEsteri p73:CreditoPrimaCasaSismaAbruzzo p73:CreditoAltriSismaAbruzzo p73:CreditoPrimaCasaU36 p73:CreditoErogazioniCultura p73:CreditoNegoziazione p73:AltriCreditiImposta

element **Crediti_Imposta_Type/Modulo**

diagram	
type	p73:Modulo_Crediti_Imposta_Type
children	p73:CreditiImpostaFondiPensione p73:CreditiImpostaRedditiEsteri p73:CreditoPrimaCasaSismaAbruzzo p73:CreditoAltriSismaAbruzzo p73:CreditoNegoziazione p73:AltriCreditiImposta

complexType **Credito_Ape**

diagram	
children	p73:Utilizzato

element **Credito_Ape/Utilizzato**

diagram	
type	DatoNP_Type

complexType **Credito_Erogazioni_Cultura_Type**

diagram	
children	p73:SpesaAnno p73:ResiduoAnnoPrec p73:RataAnnoPrec p73:RataDueAnniPrec

element **Credito_Erogazioni_Cultura_Type/SpesaAnno**

diagram	
type	DatoNP_Type

element **Credito_Erogazioni_Cultura_Type/ResiduoAnnoPrec**

diagram	
type	DatoNP_Type

element **Credito_Erogazioni_Cultura_Type/RataAnnoPrec**

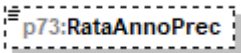
diagram	
type	DatoNP_Type

element **Credito_Erogazioni_Cultura_Type/RataDueAnniPrec**

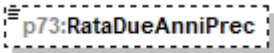
diagram	
type	DatoNP_Type

complexType **Credito_Erogazioni_Scuola_Type**

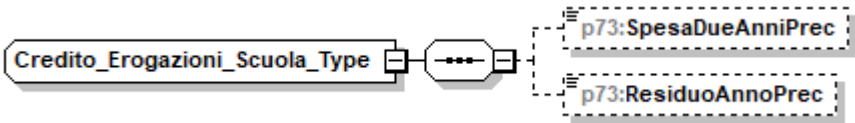
diagram	
children	p73:SpesaDueAnniPrec p73:ResiduoAnnoPrec

element **Credito_Erogazioni_Scuola_Type/SpesaDueAnniPrec**

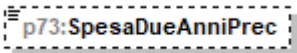
diagram	
type	DatoNP_Type

element **Credito_Erogazioni_Scuola_Type/ResiduoAnnoPrec**

diagram	
type	DatoNP_Type

complexType Credito_Immobile_Sisma_Abruzzo_Type

diagram	
children	p73:CodiceFiscale p73:NumeroRata p73:TotaleCredito

element Credito_Immobile_Sisma_Abruzzo_Type/CodiceFiscale

diagram	
type	DatoCF_Type

element Credito_Immobile_Sisma_Abruzzo_Type/NumeroRata

diagram																															
type	restriction of DatoNP_Type																														
facets	<table border="1"> <thead> <tr> <th>Kind</th> <th>Value</th> </tr> </thead> <tbody> <tr><td>enumeration</td><td>1</td></tr> <tr><td>enumeration</td><td>2</td></tr> <tr><td>enumeration</td><td>3</td></tr> <tr><td>enumeration</td><td>4</td></tr> <tr><td>enumeration</td><td>5</td></tr> <tr><td>enumeration</td><td>6</td></tr> <tr><td>enumeration</td><td>7</td></tr> <tr><td>enumeration</td><td>8</td></tr> <tr><td>enumeration</td><td>9</td></tr> <tr><td>enumeration</td><td>10</td></tr> <tr><td>enumeration</td><td>11</td></tr> <tr><td>enumeration</td><td>12</td></tr> <tr><td>enumeration</td><td>13</td></tr> <tr><td>enumeration</td><td>14</td></tr> </tbody> </table>	Kind	Value	enumeration	1	enumeration	2	enumeration	3	enumeration	4	enumeration	5	enumeration	6	enumeration	7	enumeration	8	enumeration	9	enumeration	10	enumeration	11	enumeration	12	enumeration	13	enumeration	14
Kind	Value																														
enumeration	1																														
enumeration	2																														
enumeration	3																														
enumeration	4																														
enumeration	5																														
enumeration	6																														
enumeration	7																														
enumeration	8																														
enumeration	9																														
enumeration	10																														
enumeration	11																														
enumeration	12																														
enumeration	13																														
enumeration	14																														

element Credito_Immobile_Sisma_Abruzzo_Type/TotaleCredito

diagram	
type	DatoNP_Type

complexType Credito_Negoziatore_Type

diagram	
children	p73:CreditoSpettante p73:ResiduoAnnoPrec p73:DiCuiCompensatoF24

element Credito_Negoziatore_Type/CreditoSpettante

diagram	
type	DatoNP_Type

element Credito_Negoziatore_Type/ResiduoAnnoPrec

diagram	
type	DatoNP_Type

element Credito_Negoziatore_Type/DiCuiCompensatoF24

diagram	
type	DatoNP_Type

complexType Credito_Prima_Casa_U36

diagram	
children	p73:ResiduoAnnoPrec p73:SpesaAnno p73:DiCuiCompensatoF24 p73:DiCuiCompensatoAtto

element Credito_Prima_Casa_U36/ResiduoAnnoPrec

diagram	
---------	--

type	DatoNP_Type
------	-----------------------------

element **Credito_Prima_Casa_U36/SpesaAnno**

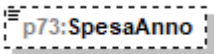
diagram	
type	DatoNP_Type

element **Credito_Prima_Casa_U36/DiCuiCompensatoF24**

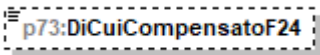
diagram	
type	DatoNP_Type

element **Credito_Prima_Casa_U36/DiCuiCompensatoAtto**

diagram	
type	DatoNP_Type

complexType **Credito_Stato_Type**

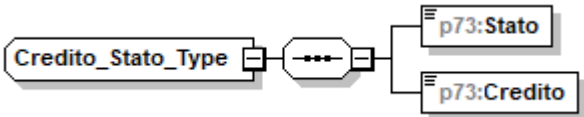
diagram	
children	p73:Stato p73:Credito

element **Credito_Stato_Type/Stato**

diagram	
type	DatoAN_Type

element **Credito_Stato_Type/Credito**

diagram	
type	DatoNP_Type

complexType Credito_Type

diagram	
children	p73:NonRimborsabile p73:Credito p73:CreditoF24 p73:CreditoRimborso

element Credito_Type/NonRimborsabile

diagram	
type	DatoNP_Type

element Credito_Type/Credito

diagram	
type	DatoNP_Type

element Credito_Type/CreditoF24

diagram	
type	DatoNP_Type

element Credito_Type/CreditoRimborso

diagram	
type	DatoNP_Type

complexType Credito_Videosorveglianza_Type

diagram	
children	p73:ResiduoAnnoPrec p73:DiCuiCompensatoF24

element **Credito_Videosorveglianza_Type/ResiduoAnnoPrec**

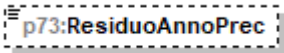
diagram	
type	DatoNP_Type

element **Credito_Videosorveglianza_Type/DiCuiCompensatoF24**

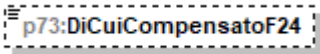
diagram	
type	DatoNP_Type

complexType **Dati_730_Integrativo_Type**

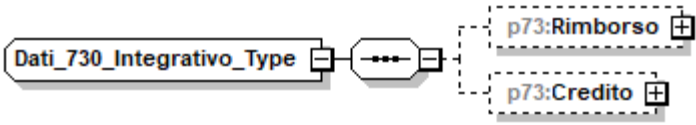
diagram	
children	p73:Rimborso p73:Credito

element **Dati_730_Integrativo_Type/Rimborso**

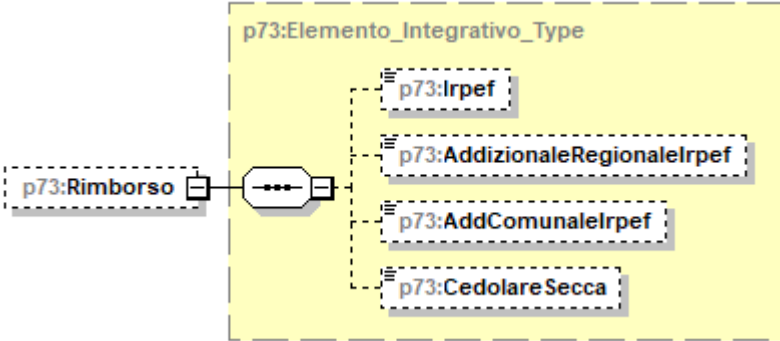
diagram	
type	p73:Elemento_Integrativo_Type
children	p73:lrpef p73:AddizionaleRegionalelrpef p73:AddComunalelrpef p73:CedolareSecca

element **Dati_730_Integrativo_Type/Credito**

diagram	
type	p73:Elemento_Integrativo_Type
children	p73:Irpef p73:AddizionaleRegionaleIrpef p73:AddComunaleIrpef p73:CedolareSecca

complexType **Dati_Altre_Detrazioni_Modulo_Type**

diagram	
children	p73:AltreDetrazioni

element **Dati_Altre_Detrazioni_Modulo_Type/AltreDetrazioni**

diagram	
type	p73:Altre_Detrazioni_Type
children	p73:Codice p73:Importo

complexType **Dati_Altre_Detrazioni_Type**

diagram	
children	p73:SpeseCaniGuida p73:AltreDetrazioni

element **Dati_Altre_Detrazioni_Type/SpeseCaniGuida**

diagram	
---------	--

type	DatoCB_Type
------	-----------------------------

element **Dati_Altre_Detrazioni_Type/AltreDetrazioni**

diagram	<p>The diagram shows a dashed box labeled 'p73:AltreDetrazioni' connected to a central octagonal connector. This connector is linked to a larger dashed box labeled 'p73:Altre_Detrazioni_Type'. Inside this larger box, there are two sub-elements: 'p73:Codice' and 'p73:Importo', each in its own dashed box.</p>
type	p73:Altre_Detrazioni_Type
children	p73:Codice p73:Importo

complexType **Dati_Catastali_Recupero_Patrimonio_Edilizio_Type**

diagram	<p>The diagram shows a box labeled 'Dati_Catastali_Recupero_Patrim...' connected to a central octagonal connector. This connector is linked to another octagonal connector, which is then connected to a dashed box labeled 'p73:NOrdImmobile'. Below this, there is another octagonal connector with a plus sign, which is connected to two dashed boxes: 'p73:Condominio' and 'p73:DatiCatastali'.</p>
children	p73:NOrdImmobile p73:Condominio p73:DatiCatastali

element **Dati_Catastali_Recupero_Patrimonio_Edilizio_Type/NOrdImmobile**

diagram	<p>The diagram shows a single dashed box labeled 'p73:NOrdImmobile'.</p>
type	DatoNP_Type

element **Dati_Catastali_Recupero_Patrimonio_Edilizio_Type/Condominio**

diagram	<p>The diagram shows a single dashed box labeled 'p73:Condominio'.</p>
type	DatoCB_Type

element **Dati_Catastali_Recupero_Patrimonio_Edilizio_Type/DatiCatastali**

<p>diagram</p>	
<p>type</p>	<p>p73:Dati_Catastali_Type</p>
<p>children</p>	<p>p73:CodiceComune p73:TerreniUrbano p73:SezioneUrbanaComuneCatastale p73:Foglio p73:Particella p73:Subalterno</p>

complexType **Dati_Catastali_Type**

<p>diagram</p>	
<p>children</p>	<p>p73:CodiceComune p73:TerreniUrbano p73:SezioneUrbanaComuneCatastale p73:Foglio p73:Particella p73:Subalterno</p>

element **Dati_Catastali_Type/CodiceComune**

<p>diagram</p>	
<p>type</p>	<p>DatoAN_Type</p>

element **Dati_Catastali_Type/TerreniUrbano**

<p>diagram</p>	
----------------	--

type	p73:Terreni_Urbano_Type						
facets	<table border="0"> <tr> <td>Kind</td> <td>Value</td> </tr> <tr> <td>enumeration</td> <td>T</td> </tr> <tr> <td>enumeration</td> <td>U</td> </tr> </table>	Kind	Value	enumeration	T	enumeration	U
Kind	Value						
enumeration	T						
enumeration	U						

element **Dati_Catastali_Type/SezioneUrbanaComuneCatastale**

diagram	
type	DatoAN_Type

element **Dati_Catastali_Type/Foglio**

diagram	
type	DatoAN_Type

element **Dati_Catastali_Type/Particella**

diagram	
children	p73:Numeratore p73:Denominatore

element **Dati_Catastali_Type/Particella/Numeratore**

diagram	
type	DatoAN_Type

element **Dati_Catastali_Type/Particella/Denominatore**

diagram	
type	DatoAN_Type

element **Dati_Catastali_Type/Subalterno**

diagram	
type	DatoAN_Type

complexType Dati_Coniuge_Type

diagram	
children	p73:Tipo p73:CodiceFiscale p73:Mesi

element Dati_Coniuge_Type/Tipo

diagram	
type	DatoCB_Type

element Dati_Coniuge_Type/CodiceFiscale

diagram	
type	DatoCF_Type

element Dati_Coniuge_Type/Mesi

diagram																											
type	p73:Mesi_Type																										
facets	<table border="1"> <thead> <tr> <th>Kind</th> <th>Value</th> </tr> </thead> <tbody> <tr><td>enumeration</td><td>1</td></tr> <tr><td>enumeration</td><td>2</td></tr> <tr><td>enumeration</td><td>3</td></tr> <tr><td>enumeration</td><td>4</td></tr> <tr><td>enumeration</td><td>5</td></tr> <tr><td>enumeration</td><td>6</td></tr> <tr><td>enumeration</td><td>7</td></tr> <tr><td>enumeration</td><td>8</td></tr> <tr><td>enumeration</td><td>9</td></tr> <tr><td>enumeration</td><td>10</td></tr> <tr><td>enumeration</td><td>11</td></tr> <tr><td>enumeration</td><td>12</td></tr> </tbody> </table>	Kind	Value	enumeration	1	enumeration	2	enumeration	3	enumeration	4	enumeration	5	enumeration	6	enumeration	7	enumeration	8	enumeration	9	enumeration	10	enumeration	11	enumeration	12
Kind	Value																										
enumeration	1																										
enumeration	2																										
enumeration	3																										
enumeration	4																										
enumeration	5																										
enumeration	6																										
enumeration	7																										
enumeration	8																										
enumeration	9																										
enumeration	10																										
enumeration	11																										
enumeration	12																										

complexType **Dati_Contabili_Type**

<p>diagram</p>	
<p>children</p>	<p>p73:Familiari p73:QuadroA p73:QuadroB p73:QuadroC p73:QuadroD p73:QuadroE p73:QuadroF p73:QuadroG p73:ProspettoLiquidazione p73:QuadroL</p>

element **Dati_Contabili_Type/Familiari**

<p>diagram</p>	
<p>type</p>	<p>p73:Familiari_Type</p>
<p>children</p>	<p>p73:PrimoModulo p73:Modulo</p>

element **Dati_Contabili_Type/QuadroA**

<p>diagram</p>	
<p>type</p>	<p>p73:Redditi_Terreni_Type</p>
<p>children</p>	<p>p73:Modulo</p>

element **Dati Contabili Type/QuadroB**

diagram	
type	p73:Redditi_Fabbricati_Type
children	p73:Modulo

element **Dati Contabili Type/QuadroC**

diagram	
type	p73:Redditi_Lavoro_Dip_Type
children	p73:PrimoModulo p73:Modulo

element **Dati Contabili Type/QuadroD**

diagram	
type	extension of p73:Altri_Redditi_Type
children	p73:Modulo

element **Dati Contabili Type/QuadroE**

diagram	
---------	--

type	p73:Oneri_Type
children	p73:PrimoModulo p73:Modulo

element **Dati_Contabili_Type/QuadroF**

diagram	
type	p73:Acconti_Ritenute_Type
children	p73:PrimoModulo p73:Modulo

element **Dati_Contabili_Type/QuadroG**

diagram	
type	p73:Crediti_Imposta_Type
children	p73:PrimoModulo p73:Modulo

element **Dati_Contabili_Type/ProspettoLiquidazione**

diagram	
type	p73:Prospetto_Liquidazione_Type
children	p73:PrimoModulo p73:Modulo

element **Dati_Contabili_Type/QuadroL**

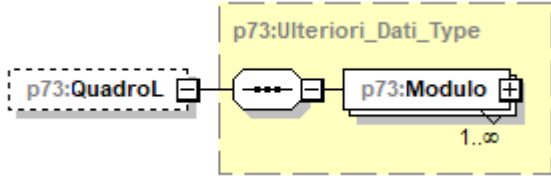
diagram	
type	p73:Ulteriori_Dati_Type
children	p73:Modulo

complexType **Dati_Contratto_Type**

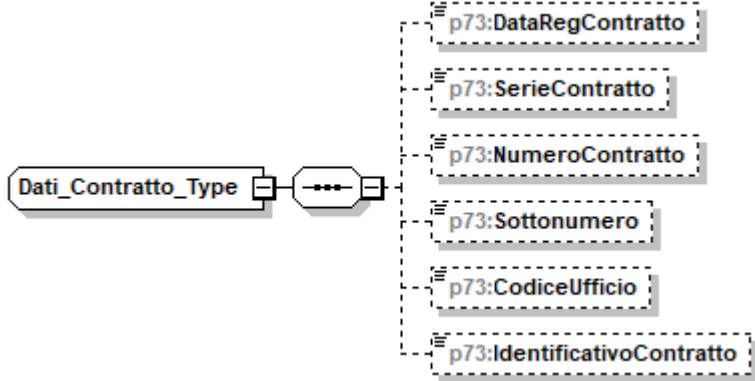
diagram	
children	p73:DataRegContratto p73:SerieContratto p73:NumeroContratto p73:Sottonumero p73:CodiceUfficio p73:IdentificativoContratto

element **Dati_Contratto_Type/DataRegContratto**

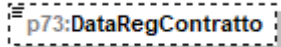
diagram	
type	DatoDT_Type

element **Dati_Contratto_Type/SerieContratto**

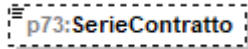
diagram															
type	p73:Serie_Registrazione_Contratto_Type														
facets	<table border="1"> <thead> <tr> <th>Kind</th> <th>Value</th> </tr> </thead> <tbody> <tr> <td>enumeration</td> <td>3</td> </tr> <tr> <td>enumeration</td> <td>3A</td> </tr> <tr> <td>enumeration</td> <td>3B</td> </tr> <tr> <td>enumeration</td> <td>3P</td> </tr> <tr> <td>enumeration</td> <td>1T</td> </tr> <tr> <td>enumeration</td> <td>3T</td> </tr> </tbody> </table>	Kind	Value	enumeration	3	enumeration	3A	enumeration	3B	enumeration	3P	enumeration	1T	enumeration	3T
Kind	Value														
enumeration	3														
enumeration	3A														
enumeration	3B														
enumeration	3P														
enumeration	1T														
enumeration	3T														

element **Dati_Contratto_Type/NumeroContratto**

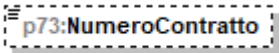
diagram	
type	DatoAN_Type

element **Dati_Contratto_Type/Sottonumero**

diagram	
type	DatoAN_Type

element **Dati_Contratto_Type/CodiceUfficio**

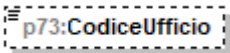
diagram	
type	restriction of DatoAN_Type

element **Dati_Contratto_Type/IdentificativoContratto**

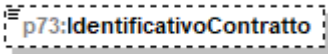
diagram	
type	DatoAN_Type

complexType **Dati_Familiare_Type**

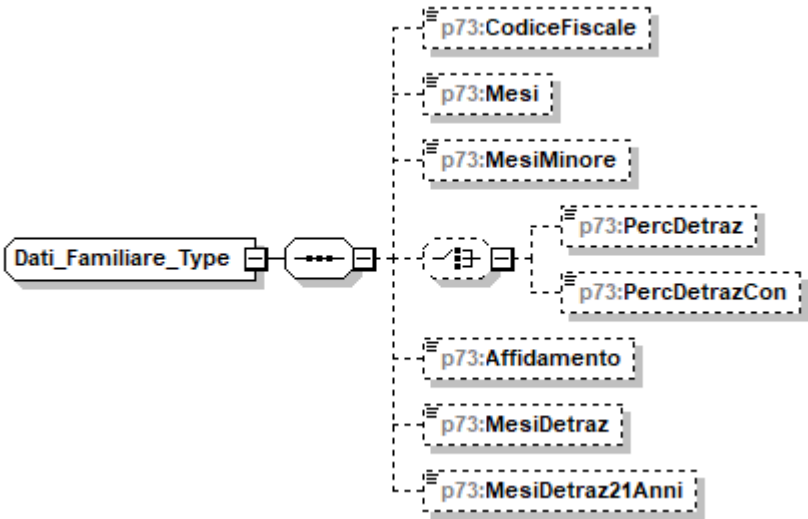
diagram	
children	p73:CodiceFiscale p73:Mesi p73:MesiMinore p73:PercDetraz p73:PercDetrazCon p73:Affidamento p73:MesiDetraz p73:MesiDetraz21Anni

element **Dati_Familiare_Type/CodiceFiscale**

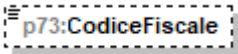
diagram	
type	DatoCF_Type

element **Dati_Familiare_Type/Mesi**

diagram	
type	DatoNP_Type

element **Dati_Familiare_Type/MesiMinore**

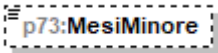
diagram	
type	DatoNP_Type

element **Dati_Familiare_Type/PercDetraz**

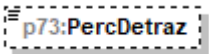
diagram	
type	DatoPC_Type

element **Dati_Familiare_Type/PercDetrazCon**

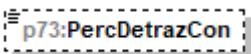
diagram	
type	DatoAN_Type

element **Dati_Familiare_Type/Affidamento**

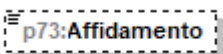
diagram	
type	DatoCB_Type

element **Dati_Familiare_Type/MesiDetraz**

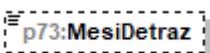
diagram	
type	DatoNP_Type

element **Dati_Familiare_Type/MesiDetraz21Anni**

diagram	
type	DatoNP_Type

complexType **Dati_Nascita_PF_Type**

diagram	
children	p73:Sesso p73:DataNascita p73:ComuneNascita p73:ProvinciaNascita

element **Dati_Nascita_PF_Type/Sesso**

diagram							
type	Sesso_Type						
facets	<table border="1"> <thead> <tr> <th>Kind</th> <th>Value</th> </tr> </thead> <tbody> <tr> <td>enumeration</td> <td>M</td> </tr> <tr> <td>enumeration</td> <td>F</td> </tr> </tbody> </table>	Kind	Value	enumeration	M	enumeration	F
Kind	Value						
enumeration	M						
enumeration	F						

element **Dati_Nascita_PF_Type/DataNascita**

diagram	
type	DatoDT_Type

element **Dati_Nascita_PF_Type/ComuneNascita**

diagram	
type	DatoAN_Type

element **Dati_Nascita_PF_Type/ProvinciaNascita**

diagram	
---------	--

type	PN_Type
------	-------------------------

complexType **Dati_Primo_Figlio_Type**

diagram	
children	p73:Tipo p73:CodiceFiscale p73:Mesi p73:MesiMinore p73:PercDetraz p73:Affidamento

element **Dati_Primo_Figlio_Type/Tipo**

diagram							
type	restriction of DatoAN_Type						
facets	<table border="1"> <thead> <tr> <th>Kind</th> <th>Value</th> </tr> </thead> <tbody> <tr> <td>enumeration</td> <td>F</td> </tr> <tr> <td>enumeration</td> <td>D</td> </tr> </tbody> </table>	Kind	Value	enumeration	F	enumeration	D
Kind	Value						
enumeration	F						
enumeration	D						

element **Dati_Primo_Figlio_Type/CodiceFiscale**

diagram	
type	DatoCF_Type

element **Dati_Primo_Figlio_Type/Mesi**

diagram																							
type	p73:Mesi_Type																						
facets	<table border="1"> <thead> <tr> <th>Kind</th> <th>Value</th> </tr> </thead> <tbody> <tr><td>enumeration</td><td>1</td></tr> <tr><td>enumeration</td><td>2</td></tr> <tr><td>enumeration</td><td>3</td></tr> <tr><td>enumeration</td><td>4</td></tr> <tr><td>enumeration</td><td>5</td></tr> <tr><td>enumeration</td><td>6</td></tr> <tr><td>enumeration</td><td>7</td></tr> <tr><td>enumeration</td><td>8</td></tr> <tr><td>enumeration</td><td>9</td></tr> <tr><td>enumeration</td><td>10</td></tr> </tbody> </table>	Kind	Value	enumeration	1	enumeration	2	enumeration	3	enumeration	4	enumeration	5	enumeration	6	enumeration	7	enumeration	8	enumeration	9	enumeration	10
Kind	Value																						
enumeration	1																						
enumeration	2																						
enumeration	3																						
enumeration	4																						
enumeration	5																						
enumeration	6																						
enumeration	7																						
enumeration	8																						
enumeration	9																						
enumeration	10																						

	enumeration	11
	enumeration	12

element **Dati_Primo_Figlio_Type/MesiMinore**

diagram																											
type	p73:Mesi_Type																										
facets	<table border="1"> <thead> <tr> <th>Kind</th> <th>Value</th> </tr> </thead> <tbody> <tr><td>enumeration</td><td>1</td></tr> <tr><td>enumeration</td><td>2</td></tr> <tr><td>enumeration</td><td>3</td></tr> <tr><td>enumeration</td><td>4</td></tr> <tr><td>enumeration</td><td>5</td></tr> <tr><td>enumeration</td><td>6</td></tr> <tr><td>enumeration</td><td>7</td></tr> <tr><td>enumeration</td><td>8</td></tr> <tr><td>enumeration</td><td>9</td></tr> <tr><td>enumeration</td><td>10</td></tr> <tr><td>enumeration</td><td>11</td></tr> <tr><td>enumeration</td><td>12</td></tr> </tbody> </table>	Kind	Value	enumeration	1	enumeration	2	enumeration	3	enumeration	4	enumeration	5	enumeration	6	enumeration	7	enumeration	8	enumeration	9	enumeration	10	enumeration	11	enumeration	12
Kind	Value																										
enumeration	1																										
enumeration	2																										
enumeration	3																										
enumeration	4																										
enumeration	5																										
enumeration	6																										
enumeration	7																										
enumeration	8																										
enumeration	9																										
enumeration	10																										
enumeration	11																										
enumeration	12																										

element **Dati_Primo_Figlio_Type/PercDetraz**

diagram	
type	DatoPC_Type

element **Dati_Primo_Figlio_Type/Affidamento**

diagram	
type	DatoCB_Type

complexType **Dati_Registrazione_Accatamento_Recupero_Patrimonio_Edilizio_Type**

diagram	
children	p73:NOrdImmobile p73:Condominio p73:EstremiRegistrazioneContratto p73:DomandaAccatamento

element **Dati_Registrazione_Accatastamento_Recupero_Patrimonio_Edilizio_Type/NOrdImmobile**

diagram	
type	DatoNP_Type

element **Dati_Registrazione_Accatastamento_Recupero_Patrimonio_Edilizio_Type/Condominio**

diagram	
type	DatoCB_Type

element **Dati_Registrazione_Accatastamento_Recupero_Patrimonio_Edilizio_Type/EstremiRegistrazioneContratto**

diagram	
type	p73:Dati_Contratto_Type
children	p73:DataRegContratto p73:SerieContratto p73:NumeroContratto p73:Sottonumero p73:CodiceUfficio p73:IdentificativoContratto

element **Dati_Registrazione_Accatastamento_Recupero_Patrimonio_Edilizio_Type/DomandaAccatastamento**

diagram	
---------	--

type	p73:Domanda Accatamento Type
children	p73:Data p73:Numero p73:ProvinciaUfficio

complexType Debito_Type

diagram	
children	p73:NonVersare p73:ImportoDaTrattenere

element Debito_Type/NonVersare

diagram	
type	DatoNP_Type

element Debito_Type/ImportoDaTrattenere

diagram	
type	DatoNP_Type

complexType Deduzioni_Modulo_Type

diagram	
children	p73:AssegnoConiuge p73:AltriOneri p73:AcquistoCostruzioneAbitLocazione

element Deduzioni_Modulo_Type/AssegnoConiuge

diagram	
type	p73:Assegno_Coniuge_Type

children	p73:CodiceFiscale p73:Importo
----------	---

element **Deduzioni_Modulo_Type/AltriOneri**

diagram	
type	p73:Altri Oneri Type
children	p73:Codice p73:Importo

element **Deduzioni_Modulo_Type/AcquistoCostruzioneAbitLocazione**

diagram	
type	p73:Acquisto Costruzione Abit Locazione
children	p73:DataStipula p73:Spesa p73:InteressiMutuo

complexType **Deduzioni_Type**

<p>diagram</p>	
<p>children</p>	<p>p73:ContributiPrevAss p73:AssegnoConiuge p73:ContributiColf p73:ErogazioniIstituzioniReligiose p73:SpesePortatoriHandicap p73:AltriOneri p73:DeducibilitaOrdinaria p73:LavoratoriPrimaOccupazione p73:FondilnSquilibrioFinanziario p73:FamiliariACarico p73:AcquistoCostruzioneAbitL... p73:RestituzioneSomme p73:ErogazioniOnlus</p>

element **Deduzioni_Type/ContributiPrevAss**

<p>diagram</p>	
<p>type</p>	<p>DatoNP_Type</p>

element **Deduzioni_Type/AssegnoConiuge**

<p>diagram</p>	
<p>type</p>	<p>p73:Assegno_Coniuge_Type</p>

children	p73:CodiceFiscale p73:Importo
----------	---

element **Deduzioni_Type/ContributiColf**

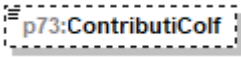
diagram	
type	DatoNP_Type

element **Deduzioni_Type/ErogazioniIstituzioniReligiose**

diagram	
type	DatoNP_Type

element **Deduzioni_Type/SpesePortatoriHandicap**

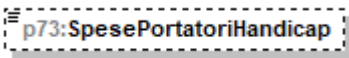
diagram	
type	DatoNP_Type

element **Deduzioni_Type/AltriOneri**

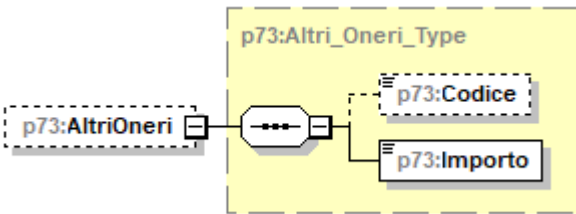
diagram	
type	p73:Altri_Oneri_Type
children	p73:Codice p73:Importo

element **Deduzioni_Type/DeducibilitaOrdinaria**

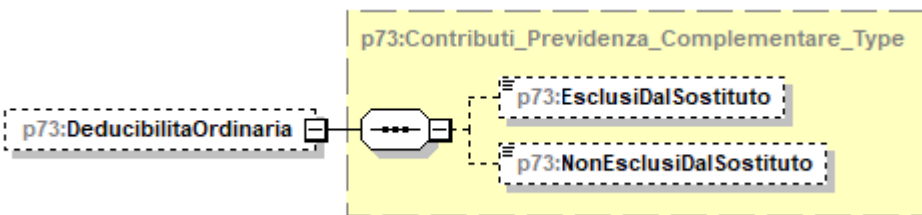
diagram	
type	p73:Contributi_Previdenza_Complementare_Type
children	p73:EsclusiDalSostituto p73:NonEsclusiDalSostituto

element **Deduzioni_Type/LavoratoriPrimaOccupazione**

diagram	
type	p73:Contributi Previdenza Complementare Type
children	p73:EsclusiDalSostituto p73:NonEsclusiDalSostituto

element **Deduzioni_Type/FondiInSquilibrioFinanziario**

diagram	
type	p73:Contributi Previdenza Complementare Type
children	p73:EsclusiDalSostituto p73:NonEsclusiDalSostituto

element **Deduzioni_Type/FamiliariACarico**

diagram	
type	p73:Contributi Previdenza Complementare Type
children	p73:EsclusiDalSostituto p73:NonEsclusiDalSostituto

element **Deduzioni_Type/AcquistoCostruzioneAbitLocazione**

<p>diagram</p>	
<p>type</p>	<p>p73:Acquisto_Costruzione_Abit_Locazione</p>
<p>children</p>	<p>p73:DataStipula p73:Spesa p73:InteressiMutuo</p>

element **Deduzioni_Type/RestituzioneSomme**

<p>diagram</p>	
<p>type</p>	<p>p73:Restituzione_Somme_Type</p>
<p>children</p>	<p>p73:SommeRestituite p73:ResiduoPrecedenteDic</p>

element **Deduzioni_Type/ErogazioniOnlus**

<p>diagram</p>	
<p>type</p>	<p>p73:Erogazioni_Onlus_Type</p>
<p>children</p>	<p>p73:Importo p73:ResiduoPrecedenteDic p73:ResiduoDueAnniPrecDic p73:ResiduoTreAnniPrecDic p73:ResiduoQuattroAnniPrecDic</p>

complexType **Detrazione_Crediti_Type**

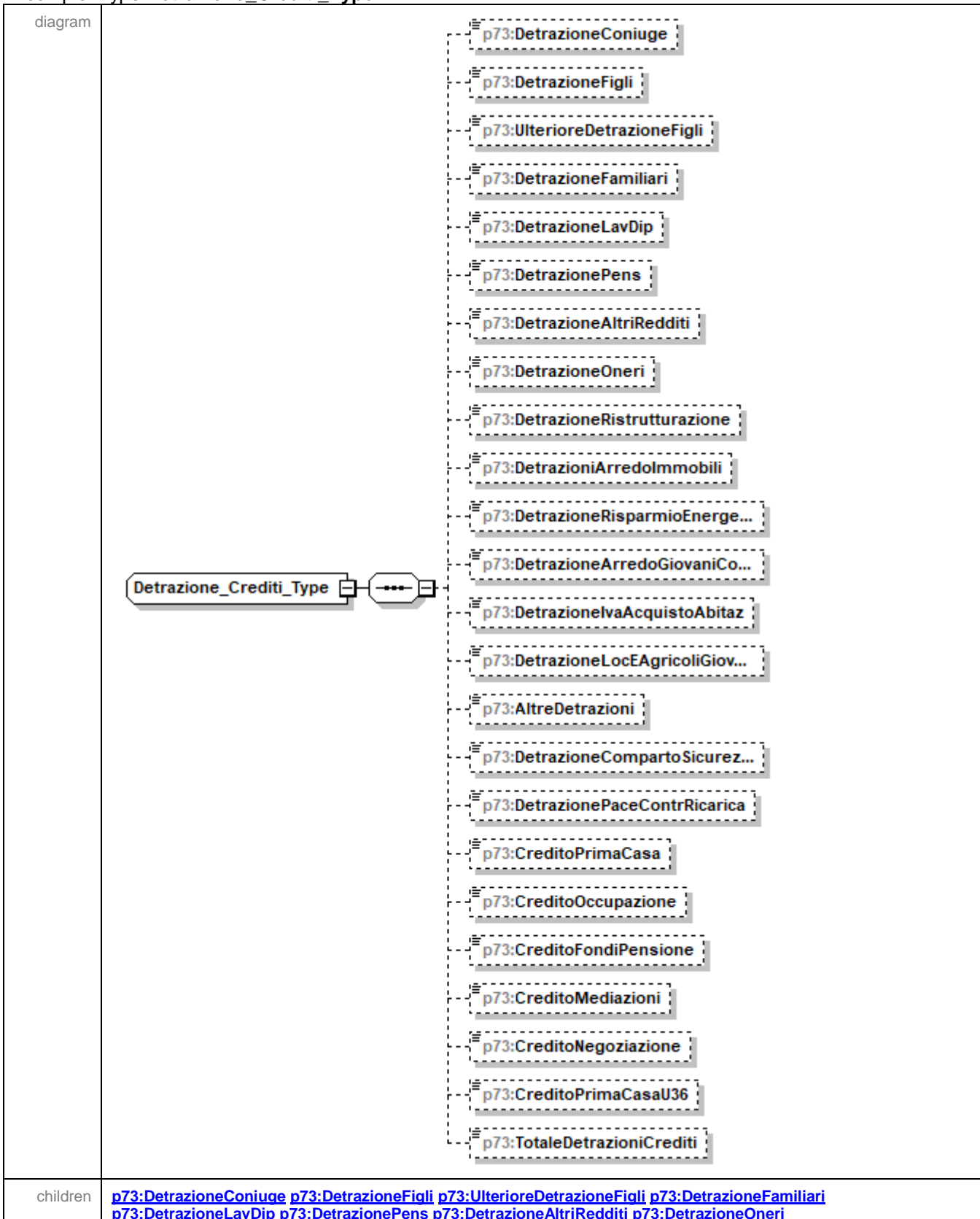

	p73:DetrazioneRistrutturazione p73:DetrazioniArredolImmobili p73:DetrazioneRisparmioEnergetico p73:DetrazioneArredoGiovaniCoppie p73:DetrazioneIvaAcquistoAbitaz p73:DetrazioneLocEAgricoliGiovani p73:AltreDetrazioni p73:DetrazioneCompartoSicurezza p73:DetrazionePaceContrRicarica p73:CreditoPrimaCasa p73:CreditoOccupazione p73:CreditoFondiPensione p73:CreditoMediazioni p73:CreditoNegoziazione p73:CreditoPrimaCasaU36 p73:TotaleDetrazioniCrediti
--	---

element **Detrazione_Crediti_Type/DetrazioneConiuge**

diagram	
type	DatoNP_Type

element **Detrazione_Crediti_Type/DetrazioneFigli**

diagram	
type	DatoNP_Type

element **Detrazione_Crediti_Type/UlterioreDetrazioneFigli**

diagram	
type	DatoNP_Type

element **Detrazione_Crediti_Type/DetrazioneFamiliari**

diagram	
type	DatoNP_Type

element **Detrazione_Crediti_Type/DetrazioneLavDip**

diagram	
type	DatoNP_Type

element **Detrazione_Crediti_Type/DetrazionePens**

diagram	
type	DatoNP_Type

element **Detrazione_Crediti_Type/DetrazioneAltriRedditi**

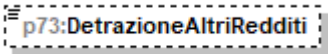
diagram	
type	DatoNP_Type

element **Detrazione_Crediti_Type/DetrazioneOneri**

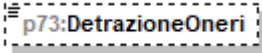
diagram	
type	DatoNP_Type

element **Detrazione_Crediti_Type/DetrazioneRistrutturazione**

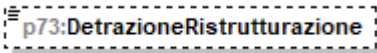
diagram	
type	DatoNP_Type

element **Detrazione_Crediti_Type/DetrazioniArredolImmobili**

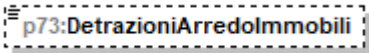
diagram	
type	DatoNP_Type

element **Detrazione_Crediti_Type/DetrazioneRisparmioEnergetico**

diagram	
type	DatoNP_Type

element **Detrazione_Crediti_Type/DetrazioneArredoGiovaniCoppie**

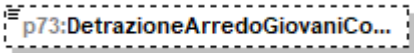
diagram	
type	DatoNP_Type

element **Detrazione_Crediti_Type/DetrazioneIvaAcquistoAbitaz**

diagram	
type	DatoNP_Type

element **Detrazione_Crediti_Type/DetrazioneLocEAgricoliGiovani**

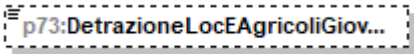
diagram	
type	DatoNP_Type

element **Detrazione_Crediti_Type/AltreDetrazioni**

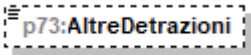
diagram	
type	DatoNP_Type

element **Detrazione_Crediti_Type/DetrazioneCompartoSicurezza**

diagram	
type	DatoNP_Type

element **Detrazione_Crediti_Type/DetrazionePaceContrRicarica**

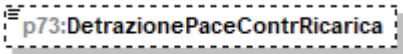
diagram	
type	DatoNP_Type

element **Detrazione_Crediti_Type/CreditoPrimaCasa**

diagram	
type	DatoNP_Type

element **Detrazione_Crediti_Type/CreditoOccupazione**

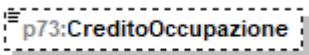
diagram	
type	DatoNP_Type

element **Detrazione_Crediti_Type/CreditoFondiPensione**

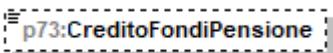
diagram	
type	DatoNP_Type

element **Detrazione_Crediti_Type/CreditoMediazioni**

diagram	
type	DatoNP_Type

element **Detrazione_Crediti_Type/CreditoNegoziazione**

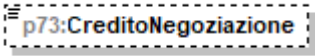
diagram	
type	DatoNP_Type

element **Detrazione_Crediti_Type/CreditoPrimaCasaU36**

diagram	
type	DatoNP_Type

element **Detrazione_Crediti_Type/TotaleDetrazioniCrediti**

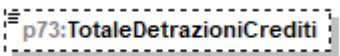
diagram	
type	DatoNP_Type

complexType **Detrazioni_Canoni_Locazione_Type**

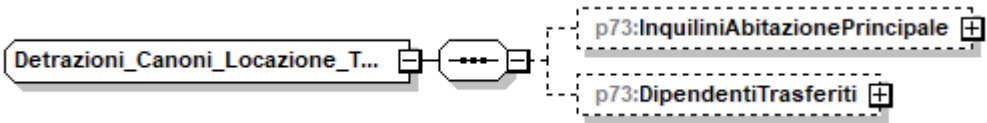
diagram	
children	p73:InquiliniAbitazionePrincipale p73:DipendentiTrasferiti

element **Detrazioni_Canoni_Locazione_Type/InquiliniAbitazionePrincipale**

diagram	
type	p73:Inquilini_Abitazione_Principale_Type
children	p73:Tipologia p73:GiorniPercentuale p73:Canone

element **Detrazioni_Canoni_Locazione_Type/DipendentiTrasferiti**

diagram	
type	p73:Giorni_Percentuale_Type
children	p73:Giorni p73:Percentuale

complexType **Detrazioni_Modulo_Type**

diagram	
children	p73:VeicoliDisabili p73:AcquistoCaniGuida p73:SpeseRateizzate p73:AltreSpese p73:SpeseLeasing

element **Detrazioni_Modulo_Type/VeicoliDisabili**

diagram	
type	p73:Spese_Rateizzate_Type
children	p73:Codice p73:Importo

element **Detrazioni_Modulo_Type/AcquistoCaniGuida**

diagram	
type	p73:Spese_Rateizzate_Type
children	p73:Codice p73:Importo

element **Detrazioni_Modulo_Type/SpeseRateizzate**

diagram	
type	p73:Spese_Rateizzate_Anni_Precedenti_Type
children	p73:Codice p73:Importo

element **Detrazioni_Modulo_Type/AltreSpese**

diagram	
type	p73:Altre_Spese_Type

children	p73:Codice p73:Importo
----------	--

element **Detrazioni_Modulo_Type/SpeseLeasing**

diagram	
type	p73:Spese_Leasing_Type
children	p73:DataStipula p73:NumeroAnno p73:Canone p73:PrezzoRiscatto

complexType **Detrazioni_Type**

diagram	
children	p73:CasellaRateazione p73:SpeseDeterminatePatologie p73:SpeseSanitarie p73:SpeseFamNonACarico p73:SpeseSanitarieDisabili p73:VeicoliDisabili p73:AcquistoCaniGuida p73:SpeseRateizzate p73:MutuiAbPrincipaleAnte p73:MutuiAbPrincipalePost p73:AltreSpese p73:SpeseLeasing

element **Detrazioni_Type/CasellaRateazione**

diagram	
type	DatoCB_Type

element **Detrazioni_Type/SpeseDeterminatePatologie**

diagram	
type	DatoNP_Type

element **Detrazioni_Type/SpeseSanitarie**

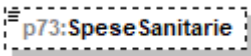
diagram	
type	DatoNP_Type

element **Detrazioni_Type/SpeseFamNonACarico**

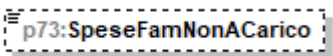
diagram	
type	DatoNP_Type

element **Detrazioni_Type/SpeseSanitarieDisabili**

diagram	
type	DatoNP_Type

element **Detrazioni_Type/VeicoliDisabili**

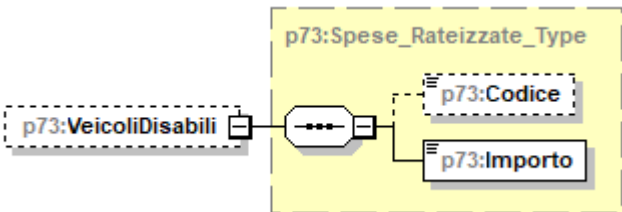
diagram	
type	p73:Spese_Rateizzate_Type
children	p73:Codice p73:Importo

element **Detrazioni_Type/AcquistoCaniGuida**

diagram	
type	p73:Spese_Rateizzate_Type
children	p73:Codice p73:Importo

element **Detrazioni_Type/SpeseRateizzate**

diagram	
type	p73:Spese_Rateizzate_Anni_Precedenti_Type
children	p73:Codice p73:Importo

element **Detrazioni_Type/MutuiAbPrincipaleAnte**

diagram	
type	DatoNP_Type

element **Detrazioni_Type/MutuiAbPrincipalePost**

diagram	
type	DatoNP_Type

element **Detrazioni_Type/AltreSpese**

diagram	
type	p73:Altre_Spese_Type
children	p73:Codice p73:Importo

element **Detrazioni_Type/SpeseLeasing**

diagram	
type	p73:Spese_Leasing_Type
children	p73:DataStipula p73:NumeroAnno p73:Canone p73:PrezzoRiscatto

complexType **Documento_P73_Type**

diagram	
children	p73:Frontespizio p73:DatiContabili p73:EsitiContabili

element **Documento_P73_Type/Frontespizio**

<p>diagram</p>	
<p>type</p>	<p>p73:Frontespizio_730_Type</p>
<p>children</p>	<p>p73:SoggettoFiscale p73:DatiAnagrafici p73:DomicilioFiscaleSaldo p73:DomicilioFiscaleAcconto p73:CasiParticolariAddizionale</p>

element **Documento_P73_Type/DatiContabili**

<p>diagram</p>	
<p>type</p>	<p>p73:Dati_Contabili_Type</p>
<p>children</p>	<p>p73:Familiari p73:QuadroA p73:QuadroB p73:QuadroC p73:QuadroD p73:QuadroE p73:QuadroF p73:QuadroG p73:ProspettoLiquidazione p73:QuadroL</p>

element **Documento_P73_Type/EsitiContabili**

diagram	
children	p73:Conguaglio

element **Documento_P73_Type/EsitiContabili/Conguaglio**

diagram	
type	p73:Conguaglio_Type
children	p73:NumeroRate p73:ImportoTrattenutoSaldo p73:ImportoTrattenutoAcconto p73:ImportoDaVersareF24Saldo p73:ImportoDaVersareF24Acconto p73:ImportoRimborsato p73:ImportoRimborsatoAgenzia p73:OpzioneInformativa

complexType **Domanda_Accatamento_Type**

diagram	
children	p73:Data p73:Numero p73:ProvinciaUfficio

element **Domanda_Accatamento_Type/Data**

diagram	
type	DatoDT_Type

element **Domanda_Accatamento_Type/Numero**

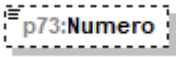
diagram	
type	DatoAN_Type

element **Domanda_Accatamento_Type/ProvinciaUfficio**

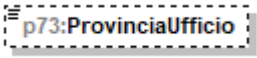
diagram	
type	PN_Type

complexType **Domicilio_Fiscale_Type**

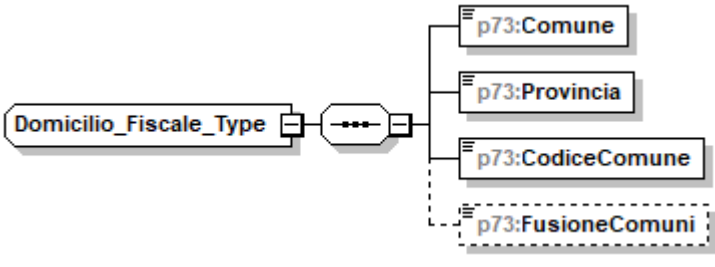
diagram	
children	p73:Comune p73:Provincia p73:CodiceComune p73:FusioneComuni

element **Domicilio_Fiscale_Type/Comune**

diagram	
type	DatoAN_Type

element **Domicilio_Fiscale_Type/Provincia**

diagram	
type	PR_Type

element **Domicilio_Fiscale_Type/CodiceComune**

diagram	
type	DatoAN_Type

element **Domicilio_Fiscale_Type/FusioneComuni**

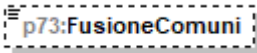
diagram	
type	DatoAN_Type

complexType **Eccedenze_Oltre_Anno_Type**

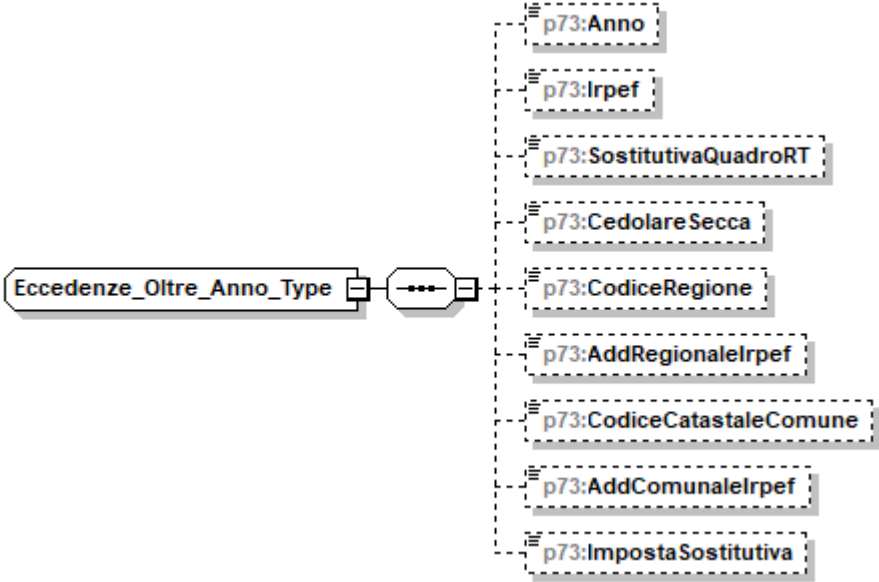
diagram	
children	p73:Anno p73:Irpef p73:SostitutivaQuadroRT p73:CedolareSecca p73:CodiceRegione p73:AddRegionaleIrpef p73:CodiceCatastaleComune p73:AddComunaleIrpef p73:ImpostaSostitutiva

element **Eccedenze_Oltre_Anno_Type/Anno**

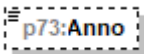
diagram	
type	DatoDA_Type

element **Eccedenze_Oltre_Anno_Type/Irpef**

diagram	
type	DatoNP_Type

element **Eccedenze_Oltre_Anno_Type/SostitutivaQuadroRT**

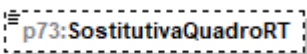
diagram	
type	DatoNP_Type

element **Eccedenze_Oltre_Anno_Type/CedolareSecca**

diagram	
type	DatoNP_Type

element **Eccedenze_Oltre_Anno_Type/CodiceRegione**

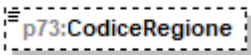
diagram																																													
type	Codice Regione_Type																																												
facets	<table border="1"> <thead> <tr> <th>Kind</th> <th>Value</th> </tr> </thead> <tbody> <tr><td>enumeration</td><td>1</td></tr> <tr><td>enumeration</td><td>2</td></tr> <tr><td>enumeration</td><td>3</td></tr> <tr><td>enumeration</td><td>4</td></tr> <tr><td>enumeration</td><td>5</td></tr> <tr><td>enumeration</td><td>6</td></tr> <tr><td>enumeration</td><td>7</td></tr> <tr><td>enumeration</td><td>8</td></tr> <tr><td>enumeration</td><td>9</td></tr> <tr><td>enumeration</td><td>10</td></tr> <tr><td>enumeration</td><td>11</td></tr> <tr><td>enumeration</td><td>12</td></tr> <tr><td>enumeration</td><td>13</td></tr> <tr><td>enumeration</td><td>14</td></tr> <tr><td>enumeration</td><td>15</td></tr> <tr><td>enumeration</td><td>16</td></tr> <tr><td>enumeration</td><td>17</td></tr> <tr><td>enumeration</td><td>18</td></tr> <tr><td>enumeration</td><td>19</td></tr> <tr><td>enumeration</td><td>20</td></tr> <tr><td>enumeration</td><td>21</td></tr> </tbody> </table>	Kind	Value	enumeration	1	enumeration	2	enumeration	3	enumeration	4	enumeration	5	enumeration	6	enumeration	7	enumeration	8	enumeration	9	enumeration	10	enumeration	11	enumeration	12	enumeration	13	enumeration	14	enumeration	15	enumeration	16	enumeration	17	enumeration	18	enumeration	19	enumeration	20	enumeration	21
Kind	Value																																												
enumeration	1																																												
enumeration	2																																												
enumeration	3																																												
enumeration	4																																												
enumeration	5																																												
enumeration	6																																												
enumeration	7																																												
enumeration	8																																												
enumeration	9																																												
enumeration	10																																												
enumeration	11																																												
enumeration	12																																												
enumeration	13																																												
enumeration	14																																												
enumeration	15																																												
enumeration	16																																												
enumeration	17																																												
enumeration	18																																												
enumeration	19																																												
enumeration	20																																												
enumeration	21																																												

element **Eccedenze_Oltre_Anno_Type/AddRegionalelrpef**

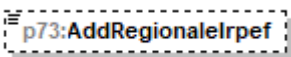
diagram	
type	DatoNP_Type

element **Eccedenze_Oltre_Anno_Type/CodiceCatastaleComune**

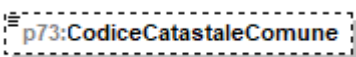
diagram	
type	restriction of DatoAN_Type

element **Eccedenze_Oltre_Anno_Type/AddComunalelrpef**

diagram	
type	DatoNP_Type

element **Eccedenze_Oltre_Anno_Type/ImpostaSostitutiva**

diagram	
type	DatoNP_Type

complexType **Eccedenze_Type**

diagram	
children	p73:lrpef p73:lrpefCompF24 p73:SostitutivaQuadroRT p73:SostitutivaQuadroRTCompF24 p73:CedolareSecca p73:CedolareSeccaCompF24 p73:CodiceRegione p73:AddRegionalelrpef p73:AddRegionalelrpefCompF24 p73:CodiceCatastaleComune p73:AddComunalelrpef p73:AddComunalelrpefF24 p73:PremioRisultato p73:PremioRisultatoCompF24

element **Eccedenze_Type/Irpef**

diagram	
type	DatoNP_Type

element **Eccedenze_Type/IrpefCompF24**

diagram	
type	DatoNP_Type

element **Eccedenze_Type/SostitutivaQuadroRT**

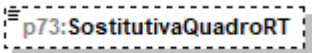
diagram	
type	DatoNP_Type

element **Eccedenze_Type/SostitutivaQuadroRTcompF24**

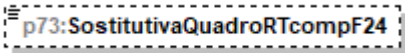
diagram	
type	DatoNP_Type

element **Eccedenze_Type/CedolareSecca**

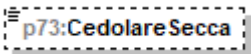
diagram	
type	DatoNP_Type

element **Eccedenze_Type/CedolareSeccaCompF24**

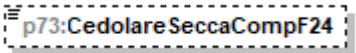
diagram	
type	DatoNP_Type

element **Eccedenze_Type/CodiceRegione**

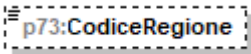
diagram					
type	Codice_Regione_Type				
facets	<table border="0"> <tr> <td>Kind</td> <td>Value</td> </tr> <tr> <td>enumeration</td> <td>1</td> </tr> </table>	Kind	Value	enumeration	1
Kind	Value				
enumeration	1				

enumeration	2
enumeration	3
enumeration	4
enumeration	5
enumeration	6
enumeration	7
enumeration	8
enumeration	9
enumeration	10
enumeration	11
enumeration	12
enumeration	13
enumeration	14
enumeration	15
enumeration	16
enumeration	17
enumeration	18
enumeration	19
enumeration	20
enumeration	21

element **Eccedenze_Type/AddRegionalelrpef**

diagram	
type	DatoNP_Type

element **Eccedenze_Type/AddRegionalelrpefCompF24**

diagram	
type	DatoNP_Type

element **Eccedenze_Type/CodiceCatastaleComune**

diagram	
type	restriction of DatoAN_Type

element **Eccedenze_Type/AddComunalelrpef**

diagram	
type	DatoNP_Type

element **Eccedenze_Type/AddComunalelrpefF24**

diagram	
---------	--

type	DatoNP_Type
------	-----------------------------

element **Eccedenze_Type/PremioRisultato**

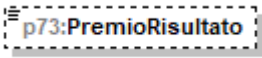
diagram	
type	DatoNP_Type

element **Eccedenze_Type/PremioRisultatoCompF24**

diagram	
type	DatoNP_Type

complexType **Elemento_Integrativo_Type**

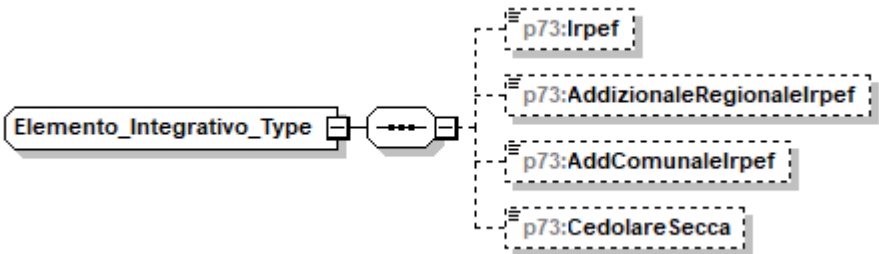
diagram	
children	p73:Irpef p73:AddizionaleRegionaleIrpef p73:AddComunaleIrpef p73:CedolareSecca

element **Elemento_Integrativo_Type/Irpef**

diagram	
type	DatoNP_Type

element **Elemento_Integrativo_Type/AddizionaleRegionaleIrpef**

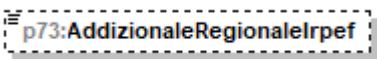
diagram	
type	DatoNP_Type

element **Elemento_Integrativo_Type/AddComunaleIrpef**

diagram	
---------	---

type	DatoNP_Type
------	-----------------------------

element **Elemento_Integrativo_Type/CedolareSecca**

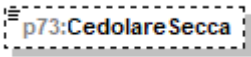
diagram	
type	DatoNP_Type

complexType **Erogazioni_Onlus_Type**

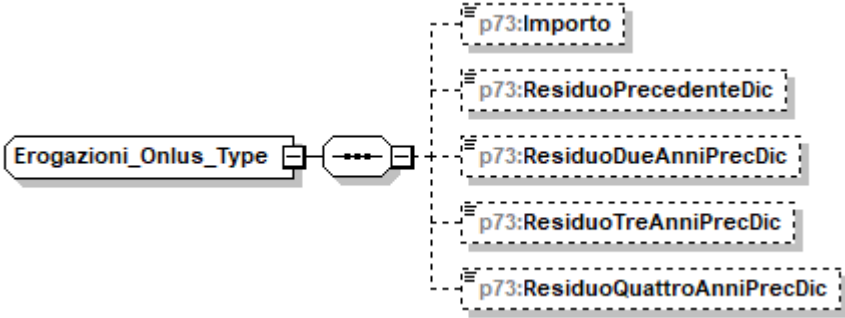
diagram	
children	p73:Importo p73:ResiduoPrecedenteDic p73:ResiduoDueAnniPrecDic p73:ResiduoTreAnniPrecDic p73:ResiduoQuattroAnniPrecDic

element **Erogazioni_Onlus_Type/Importo**

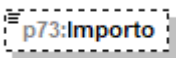
diagram	
type	DatoNP_Type

element **Erogazioni_Onlus_Type/ResiduoPrecedenteDic**

diagram	
type	DatoNP_Type

element **Erogazioni_Onlus_Type/ResiduoDueAnniPrecDic**

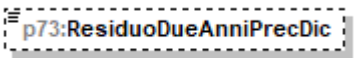
diagram	
type	DatoNP_Type

element **Erogazioni_Onlus_Type/ResiduoTreAnniPrecDic**

diagram	
type	DatoNP_Type

element **Erogazioni_Onlus_Type/ResiduoQuattroAnniPrecDic**

diagram	
type	DatoNP_Type

complexType **Esenzione_Add_Comunale_Type**

diagram	
children	p73:SogliaEsenzioneSaldo p73:SogliaEsenzioneAcconto

element **Esenzione_Add_Comunale_Type/SogliaEsenzioneSaldo**

diagram	
type	p73:Soglie_Esenzione_Type
children	p73:SogliaEsenzione p73:EsenzioneTotale

element **Esenzione_Add_Comunale_Type/SogliaEsenzioneAcconto**

diagram	
type	p73:Soglie_Esenzione_Type
children	p73:SogliaEsenzione p73:EsenzioneTotale

complexType **Esito_Liquidazione_Type**

diagram	
children	<p>p73:Credito p73:Debito</p>

element **Esito_Liquidazione_Type/Credito**

diagram	
type	<p>p73:Credito_Type</p>
children	<p>p73:NonRimborsabile p73:Credito p73:CreditoF24 p73:CreditoRimborso</p>

element **Esito_Liquidazione_Type/Debito**

diagram	
type	<p>p73:Debito_Type</p>
children	<p>p73:NonVersare p73:ImportoDaTrattenere</p>

complexType **Fabbricato_Agev_Type**

diagram	
children	<p>p73:NumeroRigoRiferimento p73:NumModuloRiferimento p73:DatiContratto p73:CasellaInf30Giorni p73:AnnoDichiarazioneIcilmu</p>

element **Fabbricato_Agev_Type/NumeroRigoRiferimento**

diagram																							
type	<p>p73:Fabbricato_Agev_Numero_Rigo_Type</p>																						
facets	<table border="1"> <thead> <tr> <th>Kind</th> <th>Value</th> </tr> </thead> <tbody> <tr><td>enumeration</td><td>1</td></tr> <tr><td>enumeration</td><td>2</td></tr> <tr><td>enumeration</td><td>3</td></tr> <tr><td>enumeration</td><td>4</td></tr> <tr><td>enumeration</td><td>5</td></tr> <tr><td>enumeration</td><td>6</td></tr> <tr><td>enumeration</td><td>7</td></tr> <tr><td>enumeration</td><td>8</td></tr> <tr><td>enumeration</td><td>9</td></tr> <tr><td>enumeration</td><td>10</td></tr> </tbody> </table>	Kind	Value	enumeration	1	enumeration	2	enumeration	3	enumeration	4	enumeration	5	enumeration	6	enumeration	7	enumeration	8	enumeration	9	enumeration	10
Kind	Value																						
enumeration	1																						
enumeration	2																						
enumeration	3																						
enumeration	4																						
enumeration	5																						
enumeration	6																						
enumeration	7																						
enumeration	8																						
enumeration	9																						
enumeration	10																						

element **Fabbricato_Agev_Type/NumModuloRiferimento**

diagram	
type	<p>DatoNP_Type</p>

element **Fabbricato_Agev_Type/DatiContratto**

<p>diagram</p>	
<p>type</p>	<p>p73:Dati_Contratto_Type</p>
<p>children</p>	<p>p73:DataRegContratto p73:SerieContratto p73:NumeroContratto p73:Sottonumero p73:CodiceUfficio p73:IdentificativoContratto</p>

element **Fabbricato_Agev_Type/CasellaInf30Giorni**

<p>diagram</p>	
<p>type</p>	<p>DatoCB_Type</p>

element **Fabbricato_Agev_Type/AnnoDichiarazioneIcilmu**

<p>diagram</p>	
<p>type</p>	<p>DatoDA_Type</p>

complexType **Fabbricato_Ord_Type**

<p>diagram</p>	
<p>children</p>	<p>p73:Rendita p73:Utilizzo p73:GiorniPossesso p73:PercPossesso p73:CodiceCanone p73:CanoneLocazione p73:CasiParticolari p73:CasellaContinuazione p73:CodiceComune p73:OpzioneCedolare p73:CasellaCasiPartimu p73:AltriDati</p>

element **Fabbricato_Ord_Type/Rendita**

<p>diagram</p>	
<p>type</p>	<p>DatoNP_Type</p>

element **Fabbricato_Ord_Type/Utilizzo**

<p>diagram</p>																							
<p>type</p>	<p>restriction of p73:Utilizzo_Fabbricato_Type</p>																						
<p>facets</p>	<table border="1"> <thead> <tr> <th>Kind</th> <th>Value</th> </tr> </thead> <tbody> <tr><td>enumeration</td><td>1</td></tr> <tr><td>enumeration</td><td>2</td></tr> <tr><td>enumeration</td><td>3</td></tr> <tr><td>enumeration</td><td>4</td></tr> <tr><td>enumeration</td><td>5</td></tr> <tr><td>enumeration</td><td>8</td></tr> <tr><td>enumeration</td><td>9</td></tr> <tr><td>enumeration</td><td>10</td></tr> <tr><td>enumeration</td><td>11</td></tr> <tr><td>enumeration</td><td>12</td></tr> </tbody> </table>	Kind	Value	enumeration	1	enumeration	2	enumeration	3	enumeration	4	enumeration	5	enumeration	8	enumeration	9	enumeration	10	enumeration	11	enumeration	12
Kind	Value																						
enumeration	1																						
enumeration	2																						
enumeration	3																						
enumeration	4																						
enumeration	5																						
enumeration	8																						
enumeration	9																						
enumeration	10																						
enumeration	11																						
enumeration	12																						

	enumeration 14
	enumeration 15
	enumeration 16
	enumeration 17

element Fabbricato_Ord_Type/GiorniPossesso

diagram	
type	restriction of DatoNP_Type

element Fabbricato_Ord_Type/PercPossesso

diagram	
type	DatoPC_Type

element Fabbricato_Ord_Type/CodiceCanone

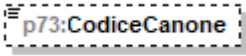
diagram											
type	p73:Codice_Canone_Type										
facets	<table border="1"> <thead> <tr> <th>Kind</th> <th>Value</th> </tr> </thead> <tbody> <tr> <td>enumeration</td> <td>1</td> </tr> <tr> <td>enumeration</td> <td>2</td> </tr> <tr> <td>enumeration</td> <td>3</td> </tr> <tr> <td>enumeration</td> <td>4</td> </tr> </tbody> </table>	Kind	Value	enumeration	1	enumeration	2	enumeration	3	enumeration	4
Kind	Value										
enumeration	1										
enumeration	2										
enumeration	3										
enumeration	4										

element Fabbricato_Ord_Type/CanoneLocazione

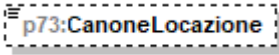
diagram	
type	DatoNP_Type

element Fabbricato_Ord_Type/CasiParticolari

diagram																	
type	p73:Casi_Particolari_Fabbricato_Type																
facets	<table border="1"> <thead> <tr> <th>Kind</th> <th>Value</th> </tr> </thead> <tbody> <tr> <td>enumeration</td> <td>1</td> </tr> <tr> <td>enumeration</td> <td>3</td> </tr> <tr> <td>enumeration</td> <td>4</td> </tr> <tr> <td>enumeration</td> <td>5</td> </tr> <tr> <td>enumeration</td> <td>6</td> </tr> <tr> <td>enumeration</td> <td>7</td> </tr> <tr> <td>enumeration</td> <td>8</td> </tr> </tbody> </table>	Kind	Value	enumeration	1	enumeration	3	enumeration	4	enumeration	5	enumeration	6	enumeration	7	enumeration	8
Kind	Value																
enumeration	1																
enumeration	3																
enumeration	4																
enumeration	5																
enumeration	6																
enumeration	7																
enumeration	8																

element **Fabbricato_Ord_Type/CasellaContinuazione**

diagram	
type	DatoCB_Type

element **Fabbricato_Ord_Type/CodiceComune**

diagram	
type	restriction of DatoAN_Type

element **Fabbricato_Ord_Type/OpzioneCedolare**

diagram	
type	DatoCB_Type

element **Fabbricato_Ord_Type/CasellaCasiPartImu**

diagram									
type	restriction of DatoN1_Type								
facets	<table border="1"> <thead> <tr> <th>Kind</th> <th>Value</th> </tr> </thead> <tbody> <tr> <td>enumeration</td> <td>1</td> </tr> <tr> <td>enumeration</td> <td>2</td> </tr> <tr> <td>enumeration</td> <td>3</td> </tr> </tbody> </table>	Kind	Value	enumeration	1	enumeration	2	enumeration	3
Kind	Value								
enumeration	1								
enumeration	2								
enumeration	3								

element **Fabbricato_Ord_Type/AltriDati**

diagram							
type	restriction of DatoN1_Type						
facets	<table border="1"> <thead> <tr> <th>Kind</th> <th>Value</th> </tr> </thead> <tbody> <tr> <td>enumeration</td> <td>1</td> </tr> <tr> <td>enumeration</td> <td>2</td> </tr> </tbody> </table>	Kind	Value	enumeration	1	enumeration	2
Kind	Value						
enumeration	1						
enumeration	2						

complexType **Familiari_Type**

diagram	
children	p73:PrimoModulo p73:Modulo

element **Familiari_Type/PrimoModulo**

<p>diagram</p>	
<p>type</p>	<p>p73:Primo_Modulo_Familiari_Type</p>
<p>children</p>	<p>p73:Coniuge p73:PrimoFiglio p73:Familiari p73:PercUlteriore p73:FigliAffidoPread</p>

element **Familiari_Type/Modulo**

<p>diagram</p>	
<p>type</p>	<p>p73:Modulo_Familiari_Type</p>
<p>children</p>	<p>p73:Coniuge p73:PrimoFiglio p73:Familiari</p>

complexType **Fondo_Pensione_Dipendenti_Pubblici_Type**

<p>diagram</p>	
<p>children</p>	<p>p73:Contributi p73:QuotaTFR</p>

element **Fondo_Pensione_Dipendenti_Pubblici_Type/Contributi**

diagram	
type	p73:Contributi Previdenza Complementare Type
children	p73:EsclusiDalSostituto p73:NonEsclusiDalSostituto

element **Fondo_Pensione_Dipendenti_Pubblici_Type/QuotaTFR**

diagram	
type	DatoNP Type

complexType **Frontespizio_730_Type**

diagram	
children	p73:SoggettoFiscale p73:DatiAnagrafici p73:DomicilioFiscaleSaldo p73:DomicilioFiscaleAcconto p73:CasiParticolariAddizionale

element **Frontespizio_730_Type/SoggettoFiscale**

diagram	
type	p73:Soggetto Fiscale 730 Type

children	p73:CodiceFiscale p73:Email p73:Telefono p73:Cellulare
----------	--

element **Frontespizio_730_Type/DatiAnagrafici**

diagram	
type	Dati_Anagrafici_Type
children	Cognome Nome Sesso DataNascita ComuneNascita ProvinciaNascita

element **Frontespizio_730_Type/DomicilioFiscaleSaldo**

diagram	
type	p73:Domicilio_Fiscale_Type
children	p73:Comune p73:Provincia p73:CodiceComune p73:FusioneComuni

element **Frontespizio_730_Type/DomicilioFiscaleAcconto**

diagram	
type	p73:Domicilio_Fiscale_Type
children	p73:Comune p73:Provincia p73:CodiceComune p73:FusioneComuni

element **Frontespizio_730_Type/CasiParticolariAddizionale**

diagram							
type	restriction of DatoN1_Type						
facets	<table border="1"> <thead> <tr> <th>Kind</th> <th>Value</th> </tr> </thead> <tbody> <tr> <td>enumeration</td> <td>1</td> </tr> <tr> <td>enumeration</td> <td>2</td> </tr> </tbody> </table>	Kind	Value	enumeration	1	enumeration	2
Kind	Value						
enumeration	1						
enumeration	2						

complexType **Giorni_Percentuale_Type**

diagram	
children	p73:Giorni p73:Percentuale

element **Giorni_Percentuale_Type/Giorni**

diagram	
type	DatoNP_Type

element **Giorni_Percentuale_Type/Percentuale**

diagram	
type	DatoPC_Type

complexType Imposta_Lorda_Type

<p>diagram</p>	
<p>children</p>	<p>p73:RedditoComplessivo p73:DeduzioneAbitazPrincipale p73:OneriDeducibili p73:RedditoImponibile p73:CompensiAttSport p73:ImportoImpostaLorda</p>

element Imposta_Lorda_Type/RedditoComplessivo

<p>diagram</p>	
<p>type</p>	<p>DatoNP_Type</p>

element Imposta_Lorda_Type/DeduzioneAbitazPrincipale

<p>diagram</p>	
<p>type</p>	<p>DatoNP_Type</p>

element Imposta_Lorda_Type/OneriDeducibili

<p>diagram</p>	
<p>type</p>	<p>DatoNP_Type</p>

element Imposta_Lorda_Type/RedditoImponibile

<p>diagram</p>	
<p>type</p>	<p>DatoNP_Type</p>

element Imposta_Lorda_Type/CompensiAttSport

<p>diagram</p>	
----------------	--

type	DatoNP_Type
------	-----------------------------

element **Imposta_Lorda_Type/ImportoImpostaLorda**

diagram	
type	DatoNP_Type

complexType **Imposta_Netta_Type**

diagram	
children	p73:ImportoImpostaNetta p73:CredAltriSisma p73:CredAbitazSisma p73:CredImpEstere p73:CredErogCultura p73:CredErogScuola p73:CredVideosorveglianza p73:AltriCrediti p73:CredDetrazIncapienti p73:Ritenute p73:Differenza p73:EccedenzaIrf p73:AccontiVersati p73:RestituzioneBonus p73:CredRimborsatiSost p73:TrattamentoIntSpettante p73:TrattamentoIntRiconosciuto p73:RestituzioneTrattamentoInt

p73:TrattamentoIntSpettante p73:TrattamentoIntRiconosciuto p73:RestituzioneTrattamentoInt

element Imposta_Netta_Type/ImportoImpostaNetta

diagram	
type	DatoNP_Type

element Imposta_Netta_Type/CredAltriSisma

diagram	
type	DatoNP_Type

element Imposta_Netta_Type/CredAbitazSisma

diagram	
type	DatoNP_Type

element Imposta_Netta_Type/CredImpEstere

diagram	
type	DatoNP_Type

element Imposta_Netta_Type/CredErogCultura

diagram	
type	DatoNP_Type

element Imposta_Netta_Type/CredErogScuola

diagram	
type	DatoNP_Type

element Imposta_Netta_Type/CredVideosorveglianza

diagram	
---------	--

type	DatoNP_Type
------	-----------------------------

element **Imposta_Netta_Type/AltriCrediti**

diagram	
type	DatoNP_Type

element **Imposta_Netta_Type/CredDetrazIncapienti**

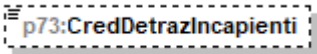
diagram	
type	DatoNP_Type

element **Imposta_Netta_Type/Ritenute**

diagram	
type	DatoNP_Type

element **Imposta_Netta_Type/Differenza**

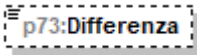
diagram	
type	DatoNU_Type

element **Imposta_Netta_Type/Eccedenzarpef**

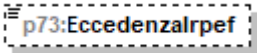
diagram	
type	DatoNU_Type

element **Imposta_Netta_Type/AccontiVersati**

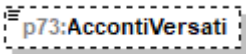
diagram	
type	DatoNP_Type

element Imposta_Netta_Type/RestituzioneBonus

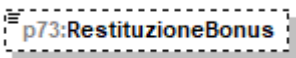
diagram	
type	DatoNP_Type

element Imposta_Netta_Type/CredRimborsatiSost

diagram	
type	DatoNP_Type

element Imposta_Netta_Type/TrattamentoIntSpettante

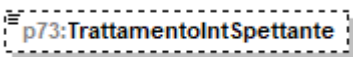
diagram	
type	DatoNP_Type

element Imposta_Netta_Type/TrattamentoIntRiconosciuto

diagram	
type	DatoNP_Type

element Imposta_Netta_Type/RestituzioneTrattamentoInt

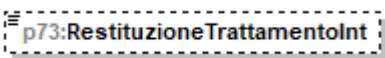
diagram	
type	DatoNP_Type

complexType Imposte_Rimborsate_Type

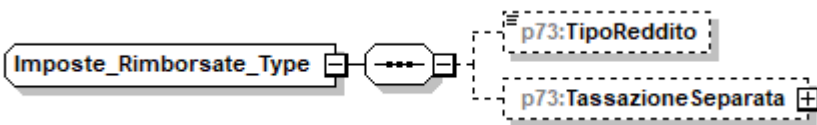
diagram	
children	p73:TipoReddito p73:TassazioneSeparata

element Imposte_Rimborsate_Type/TipoReddito

diagram	
type	p73:Tipo_Reddito_Da1a8_Type

facets	Kind	Value
	enumeration	1
	enumeration	2
	enumeration	3
	enumeration	4
	enumeration	5
	enumeration	6
	enumeration	7
	enumeration	8

element **Imposte_Rimborsate_Type/TassazioneSeparata**

diagram	
type	p73:Tassazione_Separata_Type
children	p73:Opzione p73:Anno p73:RedditoRitenute

complexType **Incremento_Produttivita_Type**

diagram	
children	p73:ImportoTassazOrdinaria p73:ImportoImpostaSostitutiva p73:RitenuteImpostaSostitutiva p73:Art51Ordinaria p73:Art51Sostitutiva p73:TassazOrdinaria p73:TassazSostitutiva

element **Incremento_Produttivita_Type/ImportoTassazOrdinaria**

diagram	
type	DatoNP_Type

element **Incremento_Produttivita_Type/ImportoImpostaSostitutiva**

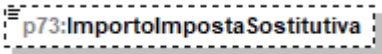
diagram	
type	DatoNP_Type

element **Incremento_Produttivita_Type/RitenuteImpostaSostitutiva**

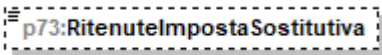
diagram	
type	DatoNP_Type

element **Incremento_Produttivita_Type/Art51Ordinaria**

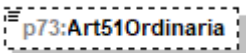
diagram	
type	DatoNP_Type

element **Incremento_Produttivita_Type/Art51Sostitutiva**

diagram	
type	DatoNP_Type

element **Incremento_Produttivita_Type/TassazOrdinaria**

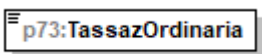
diagram	
type	DatoCB_Type

element **Incremento_Produttivita_Type/TassazSostitutiva**

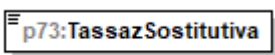
diagram	
type	DatoCB_Type

complexType Inquilini_Abitazione_Principale_Type

diagram	
children	p73:Tipologia p73:GiorniPercentuale p73:Canone

element Inquilini_Abitazione_Principale_Type/Tipologia

diagram									
type	p73:Tipo_Inquilino_Type								
facets	<table border="1"> <thead> <tr> <th>Kind</th> <th>Value</th> </tr> </thead> <tbody> <tr> <td>enumeration</td> <td>1</td> </tr> <tr> <td>enumeration</td> <td>2</td> </tr> <tr> <td>enumeration</td> <td>4</td> </tr> </tbody> </table>	Kind	Value	enumeration	1	enumeration	2	enumeration	4
Kind	Value								
enumeration	1								
enumeration	2								
enumeration	4								

element Inquilini_Abitazione_Principale_Type/GiorniPercentuale

diagram	
type	p73:Giorni_Percentuale_Type
children	p73:Giorni p73:Percentuale

element Inquilini_Abitazione_Principale_Type/Canone

diagram	
type	DatoNP_Type

complexType **Intervento_Ricupero_Patrimonio_Edilizio_Type**

<p>diagram</p>	
<p>children</p>	<p>p73:Anno p73:Periodo p73:CodiceFiscale p73:CasellaInterventiParticolari p73:CodiceSituazioniParticolari p73:MaggiorazioneSisma p73:Casella110 p73:Rate10 p73:Spesa p73:NOordinelImmobile</p>

element **Intervento_Ricupero_Patrimonio_Edilizio_Type/Anno**

<p>diagram</p>																							
<p>type</p>	<p>restriction of p73:Anno_Ricupero_Patrimonio_Edilizio_Type</p>																						
<p>facets</p>	<table border="1"> <thead> <tr> <th>Kind</th> <th>Value</th> </tr> </thead> <tbody> <tr><td>enumeration</td><td>2013</td></tr> <tr><td>enumeration</td><td>2014</td></tr> <tr><td>enumeration</td><td>2015</td></tr> <tr><td>enumeration</td><td>2016</td></tr> <tr><td>enumeration</td><td>2017</td></tr> <tr><td>enumeration</td><td>2018</td></tr> <tr><td>enumeration</td><td>2019</td></tr> <tr><td>enumeration</td><td>2020</td></tr> <tr><td>enumeration</td><td>2021</td></tr> <tr><td>enumeration</td><td>2022</td></tr> </tbody> </table>	Kind	Value	enumeration	2013	enumeration	2014	enumeration	2015	enumeration	2016	enumeration	2017	enumeration	2018	enumeration	2019	enumeration	2020	enumeration	2021	enumeration	2022
Kind	Value																						
enumeration	2013																						
enumeration	2014																						
enumeration	2015																						
enumeration	2016																						
enumeration	2017																						
enumeration	2018																						
enumeration	2019																						
enumeration	2020																						
enumeration	2021																						
enumeration	2022																						

element **Intervento_Ricupero_Patrimonio_Edilizio_Type/Periodo**

<p>diagram</p>													
<p>type</p>	<p>p73:Periodo_Spese_Ristrutturazione_Type</p>												
<p>facets</p>	<table border="1"> <thead> <tr> <th>Kind</th> <th>Value</th> </tr> </thead> <tbody> <tr><td>enumeration</td><td>2</td></tr> <tr><td>enumeration</td><td>3</td></tr> <tr><td>enumeration</td><td>4</td></tr> <tr><td>enumeration</td><td>5</td></tr> <tr><td>enumeration</td><td>6</td></tr> </tbody> </table>	Kind	Value	enumeration	2	enumeration	3	enumeration	4	enumeration	5	enumeration	6
Kind	Value												
enumeration	2												
enumeration	3												
enumeration	4												
enumeration	5												
enumeration	6												

	enumeration 7
	enumeration 8
	enumeration 9
	enumeration 10
	enumeration 11
	enumeration 12
	enumeration 13
	enumeration 15
	enumeration 16
	enumeration 17
	enumeration 18
	enumeration 19
	enumeration 20
	enumeration 21
	enumeration 22

element **Intervento_Ricupero_Patrimonio_Edilizio_Type/CodiceFiscale**

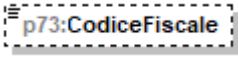
diagram	
type	DatoCF_Type

element **Intervento_Ricupero_Patrimonio_Edilizio_Type/CasellaInterventiParticolari**

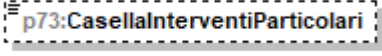
diagram							
type	restriction of DatoN1_Type						
facets	<table border="1"> <tr> <td>Kind</td> <td>Value</td> </tr> <tr> <td>enumeration</td> <td>1</td> </tr> <tr> <td>enumeration</td> <td>4</td> </tr> </table>	Kind	Value	enumeration	1	enumeration	4
Kind	Value						
enumeration	1						
enumeration	4						

element **Intervento_Ricupero_Patrimonio_Edilizio_Type/CodiceSituazioniParticolari**

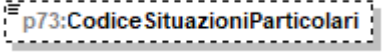
diagram					
type	p73:Casella_Codice_Type				
facets	<table border="1"> <tr> <td>Kind</td> <td>Value</td> </tr> <tr> <td>enumeration</td> <td>4</td> </tr> </table>	Kind	Value	enumeration	4
Kind	Value				
enumeration	4				

element **Intervento_Ricupero_Patrimonio_Edilizio_Type/MaggiorazioneSisma**

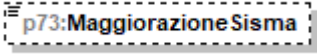
diagram	
type	DatoCB_Type

element **Intervento_Ricupero_Patrimonio_Edilizio_Type/Casella110**

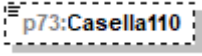
diagram	
---------	---

type	DatoCB_Type
------	-----------------------------

element **Intervento_Ricupero_Patrimonio_Edilizio_Type/Rate10**

diagram																							
type	p73:Rate10_Type																						
facets	<table border="1"> <thead> <tr> <th>Kind</th> <th>Value</th> </tr> </thead> <tbody> <tr><td>enumeration</td><td>1</td></tr> <tr><td>enumeration</td><td>2</td></tr> <tr><td>enumeration</td><td>3</td></tr> <tr><td>enumeration</td><td>4</td></tr> <tr><td>enumeration</td><td>5</td></tr> <tr><td>enumeration</td><td>6</td></tr> <tr><td>enumeration</td><td>7</td></tr> <tr><td>enumeration</td><td>8</td></tr> <tr><td>enumeration</td><td>9</td></tr> <tr><td>enumeration</td><td>10</td></tr> </tbody> </table>	Kind	Value	enumeration	1	enumeration	2	enumeration	3	enumeration	4	enumeration	5	enumeration	6	enumeration	7	enumeration	8	enumeration	9	enumeration	10
Kind	Value																						
enumeration	1																						
enumeration	2																						
enumeration	3																						
enumeration	4																						
enumeration	5																						
enumeration	6																						
enumeration	7																						
enumeration	8																						
enumeration	9																						
enumeration	10																						

element **Intervento_Ricupero_Patrimonio_Edilizio_Type/Spesa**

diagram	
type	DatoNP_Type

element **Intervento_Ricupero_Patrimonio_Edilizio_Type/NOrdineImmobile**

diagram	
type	DatoNP_Type

complexType **Intervento_Risparmio_Energetico_Type**

<p>diagram</p>	
<p>children</p>	<p>p73:TipIntervento p73:Anno p73:Periodo2013 p73:CasiParticolari p73:RideterminazioneRate p73:Casella110 p73:NumeroRata p73:Spesa p73:MaggiorazioneSisma</p>

element **Intervento_Risparmio_Energetico_Type/TipIntervento**

<p>diagram</p>																																											
<p>type</p>	<p>p73:Tipo Intervento Type</p>																																										
<p>facets</p>	<table border="1"> <thead> <tr> <th>Kind</th> <th>Value</th> </tr> </thead> <tbody> <tr><td>enumeration</td><td>1</td></tr> <tr><td>enumeration</td><td>2</td></tr> <tr><td>enumeration</td><td>3</td></tr> <tr><td>enumeration</td><td>4</td></tr> <tr><td>enumeration</td><td>5</td></tr> <tr><td>enumeration</td><td>6</td></tr> <tr><td>enumeration</td><td>7</td></tr> <tr><td>enumeration</td><td>8</td></tr> <tr><td>enumeration</td><td>9</td></tr> <tr><td>enumeration</td><td>10</td></tr> <tr><td>enumeration</td><td>11</td></tr> <tr><td>enumeration</td><td>12</td></tr> <tr><td>enumeration</td><td>13</td></tr> <tr><td>enumeration</td><td>14</td></tr> <tr><td>enumeration</td><td>15</td></tr> <tr><td>enumeration</td><td>16</td></tr> <tr><td>enumeration</td><td>30</td></tr> <tr><td>enumeration</td><td>31</td></tr> <tr><td>enumeration</td><td>32</td></tr> <tr><td>enumeration</td><td>33</td></tr> </tbody> </table>	Kind	Value	enumeration	1	enumeration	2	enumeration	3	enumeration	4	enumeration	5	enumeration	6	enumeration	7	enumeration	8	enumeration	9	enumeration	10	enumeration	11	enumeration	12	enumeration	13	enumeration	14	enumeration	15	enumeration	16	enumeration	30	enumeration	31	enumeration	32	enumeration	33
Kind	Value																																										
enumeration	1																																										
enumeration	2																																										
enumeration	3																																										
enumeration	4																																										
enumeration	5																																										
enumeration	6																																										
enumeration	7																																										
enumeration	8																																										
enumeration	9																																										
enumeration	10																																										
enumeration	11																																										
enumeration	12																																										
enumeration	13																																										
enumeration	14																																										
enumeration	15																																										
enumeration	16																																										
enumeration	30																																										
enumeration	31																																										
enumeration	32																																										
enumeration	33																																										

element **Intervento_Risparmio_Energetico_Type/Anno**

<p>diagram</p>	
----------------	--

type	restriction of p73:Anno Risparmio Energetico Type	
facets	Kind	Value
	enumeration	2008
	enumeration	2013
	enumeration	2014
	enumeration	2015
	enumeration	2016
	enumeration	2017
	enumeration	2018
	enumeration	2019
	enumeration	2020
	enumeration	2021
	enumeration	2022

element [Intervento_Risparmio_Energetico_Type/Periodo2013](#)

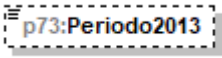
diagram		
type	restriction of DatoN1 Type	
facets	Kind	Value
	enumeration	1
	enumeration	2

element [Intervento_Risparmio_Energetico_Type/CasiParticolari](#)

diagram		
type	p73:Casi Particolari Risp Ener Type	
facets	Kind	Value
	enumeration	1
	enumeration	2
	enumeration	3

element [Intervento_Risparmio_Energetico_Type/RideterminazioneRate](#)

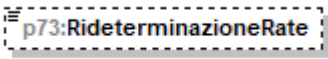
diagram		
type	p73:Rate Risparmio Energetico Type	
facets	Kind	Value
	enumeration	6
	enumeration	7
	enumeration	8
	enumeration	9
	enumeration	10

element [Intervento_Risparmio_Energetico_Type/Casella110](#)

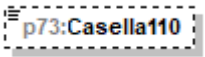
diagram		
type	DatoCB Type	

element **Intervento_Risparmio_Energetico_Type/NumeroRata**

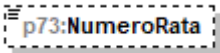
diagram																							
type	p73:Numero Rata Risparmio Energetico Type																						
facets	<table border="1"> <thead> <tr> <th>Kind</th> <th>Value</th> </tr> </thead> <tbody> <tr><td>enumeration</td><td>1</td></tr> <tr><td>enumeration</td><td>2</td></tr> <tr><td>enumeration</td><td>3</td></tr> <tr><td>enumeration</td><td>4</td></tr> <tr><td>enumeration</td><td>5</td></tr> <tr><td>enumeration</td><td>6</td></tr> <tr><td>enumeration</td><td>7</td></tr> <tr><td>enumeration</td><td>8</td></tr> <tr><td>enumeration</td><td>9</td></tr> <tr><td>enumeration</td><td>10</td></tr> </tbody> </table>	Kind	Value	enumeration	1	enumeration	2	enumeration	3	enumeration	4	enumeration	5	enumeration	6	enumeration	7	enumeration	8	enumeration	9	enumeration	10
Kind	Value																						
enumeration	1																						
enumeration	2																						
enumeration	3																						
enumeration	4																						
enumeration	5																						
enumeration	6																						
enumeration	7																						
enumeration	8																						
enumeration	9																						
enumeration	10																						

element **Intervento_Risparmio_Energetico_Type/Spesa**

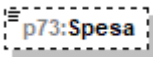
diagram	
type	DatoNP Type

element **Intervento_Risparmio_Energetico_Type/MaggiorazioneSisma**

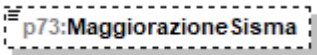
diagram	
type	DatoCB Type

complexType **Iva_Acquisto_Abitazione_Type**

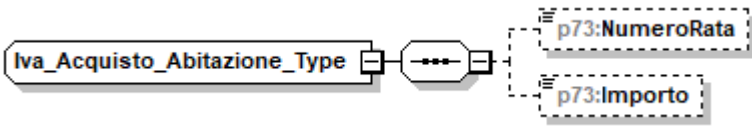
diagram	
children	p73:NumeroRata p73:Importo

element **Iva_Acquisto_Abitazione_Type/NumeroRata**

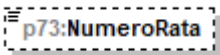
diagram							
type	restriction of DatoNP Type						
facets	<table border="1"> <thead> <tr> <th>Kind</th> <th>Value</th> </tr> </thead> <tbody> <tr><td>enumeration</td><td>6</td></tr> <tr><td>enumeration</td><td>7</td></tr> </tbody> </table>	Kind	Value	enumeration	6	enumeration	7
Kind	Value						
enumeration	6						
enumeration	7						

element **Iva_Acquisto_Abitazione_Type/Importo**

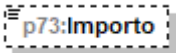
diagram	
type	DatoNP_Type

complexType **Lavoro_Dipendente_Type**

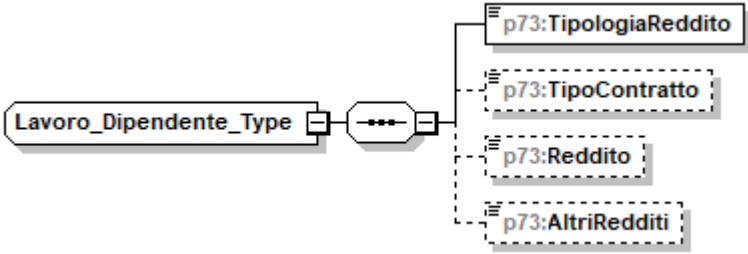
diagram	
children	p73:TipologiaReddito p73:TipoContratto p73:Reddito p73:AltriRedditi

element **Lavoro_Dipendente_Type/TipologiaReddito**

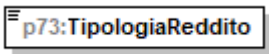
diagram													
type	restriction of DatoN1_Type												
facets	<table border="1"> <thead> <tr> <th>Kind</th> <th>Value</th> </tr> </thead> <tbody> <tr> <td>enumeration</td> <td>1</td> </tr> <tr> <td>enumeration</td> <td>2</td> </tr> <tr> <td>enumeration</td> <td>3</td> </tr> <tr> <td>enumeration</td> <td>4</td> </tr> <tr> <td>enumeration</td> <td>7</td> </tr> </tbody> </table>	Kind	Value	enumeration	1	enumeration	2	enumeration	3	enumeration	4	enumeration	7
Kind	Value												
enumeration	1												
enumeration	2												
enumeration	3												
enumeration	4												
enumeration	7												

element **Lavoro_Dipendente_Type/TipoContratto**

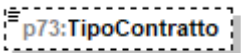
diagram							
type	p73:Indeterminato Determinato_Type						
facets	<table border="1"> <thead> <tr> <th>Kind</th> <th>Value</th> </tr> </thead> <tbody> <tr> <td>enumeration</td> <td>1</td> </tr> <tr> <td>enumeration</td> <td>2</td> </tr> </tbody> </table>	Kind	Value	enumeration	1	enumeration	2
Kind	Value						
enumeration	1						
enumeration	2						

element **Lavoro_Dipendente_Type/Reddito**

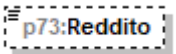
diagram	
type	DatoNP_Type

element **Lavoro_Dipendente_Type/AltriRedditi**

diagram									
type	restriction of DatoN1_Type								
facets	<table border="1"> <thead> <tr> <th>Kind</th> <th>Value</th> </tr> </thead> <tbody> <tr> <td>enumeration</td> <td>1</td> </tr> <tr> <td>enumeration</td> <td>2</td> </tr> <tr> <td>enumeration</td> <td>5</td> </tr> </tbody> </table>	Kind	Value	enumeration	1	enumeration	2	enumeration	5
Kind	Value								
enumeration	1								
enumeration	2								
enumeration	5								

complexType **Locazioni_Brevi_Type**

diagram	
children	p73:Ritenute

element **Locazioni_Brevi_Type/Ritenute**

diagram	
type	DatoNP_Type

complexType **Misura_Acconti_Type**

diagram	
children	p73:IrpefMisuralInferiore p73:AddComunaleMisuralInferiore p73:CedolareSeccaMisuralInferiore p73:NumeroRate

element **Misura_Acconti_Type/IrpefMisuralInferiore**

diagram	
type	p73:Casella_Acconto_Type
children	p73:Casella p73:ImportoMisuralInferiore

element **Misura_Acconti_Type/AddComunaleMisuralInferiore**

diagram	
type	p73:Casella_Acconto_Type
children	p73:Casella p73:ImportoMisuralInferiore

element **Misura_Acconti_Type/CedolareSeccaMisuralInferiore**

diagram	
type	p73:Casella_Acconto_Type
children	p73:Casella p73:ImportoMisuralInferiore

element **Misura_Acconti_Type/NumeroRate**

diagram															
type	restriction of DatoN1_Type														
facets	<table border="1"> <thead> <tr> <th>Kind</th> <th>Value</th> </tr> </thead> <tbody> <tr> <td>enumeration</td> <td>2</td> </tr> <tr> <td>enumeration</td> <td>3</td> </tr> <tr> <td>enumeration</td> <td>4</td> </tr> <tr> <td>enumeration</td> <td>5</td> </tr> <tr> <td>enumeration</td> <td>6</td> </tr> <tr> <td>enumeration</td> <td>7</td> </tr> </tbody> </table>	Kind	Value	enumeration	2	enumeration	3	enumeration	4	enumeration	5	enumeration	6	enumeration	7
Kind	Value														
enumeration	2														
enumeration	3														
enumeration	4														
enumeration	5														
enumeration	6														
enumeration	7														

complexType **Modulo_Altri_Reddit_Type**

diagram	
children	p73:RedditiDiCapitale p73:RedditiTassazioneSeparata

element **Modulo_Altri_Reddit_Type/RedditiDiCapitale**

diagram	
type	p73:Redditi_Capitale_Type
children	p73:Utili p73:AltriRedditiDiCapitale p73:LavoroAutonomo p73:RedditiDiversi p73:RedditiDiversiDetraz

element **Modulo_Altri_Reddit_Type/RedditiTassazioneSeparata**

diagram	
type	p73:Redditi_Tassazione_Separata_Type
children	p73:RedditiErede p73:ImposteRimborsate

complexType **Modulo_Crediti_Imposta_Type**

diagram	
children	p73:CreditiImpostaFondiPensione p73:CreditiImpostaRedditiEsteri p73:CreditoPrimaCasaSismaAbruzzo p73:CreditoAltriSismaAbruzzo p73:CreditoNegoziazione p73:AltriCreditiImposta

element **Modulo_Crediti_Imposta_Type/CreditiImpostaFondiPensione**

<p>diagram</p>	
<p>type</p>	<p>p73:Crediti_Imposta_Fondi_Pensione_Type</p>
<p>children</p>	<p>p73:AnnoAnticipazione p73:Reintegro p73:SommaReintegrata p73:CreditoAnno</p>

element **Modulo_Crediti_Imposta_Type/CreditiImpostaRedditiEsteri**

<p>diagram</p>	
<p>type</p>	<p>p73:Crediti_Imposta_Redditi_Esteri_Type</p>
<p>children</p>	<p>p73:StatoEstero p73:Anno p73:RedditoEstero p73:ImpostaEstera p73:RedditoComplessivo p73:Imposta_Lorda p73:ImpostaNetta p73:CreditoDichiarazioniPrecedenti p73:DiCuiStatoEstero</p>

element **Modulo_Crediti_Imposta_Type/CreditoPrimaCasaSismaAbruzzo**

diagram	
type	p73:Credito_Immobil..._Sisma_Abruzzo_Type
children	p73:CodiceFiscale p73:NumeroRata p73:TotaleCredito

element **Modulo_Crediti_Imposta_Type/CreditoAltriSismaAbruzzo**

diagram	
type	p73:Crediti_Imposta_Altri_Sisma_Abruzzo_Type
children	p73:Impresa_Professione p73:CodiceFiscale p73:NumeroRata p73:TotaleCredito p73:Rateazione

element **Modulo_Crediti_Imposta_Type/CreditoNegoziazione**

diagram	
type	p73:Modulo_Credito_Negozi..._Type
children	p73:CreditoSpettante

element **Modulo_Crediti_Imposta_Type/AltriCreditiImposta**

<p>diagram</p>	
<p>type</p>	<p>p73:Altri_Crediti_Imposta_Type</p>
<p>children</p>	<p>p73:Codice p73:Importo p73:ResiduoAnnoPrec p73:RataDueAnniPrec p73:DiCuiCompensatoF24</p>

complexType **Modulo_Credito_Negoziatore_Type**

<p>diagram</p>	
<p>children</p>	<p>p73:CreditoSpettante</p>

element **Modulo_Credito_Negoziatore_Type/CreditoSpettante**

<p>diagram</p>	
<p>type</p>	<p>DatoNP_Type</p>

complexType **Modulo_Fabbricato_Type**

<p>diagram</p>	
<p>children</p>	<p>p73:FabbricatoOrd p73:FabbricatoAgev</p>

element **Modulo_Fabbricato_Type/FabbricatoOrd**

<p>diagram</p>	
<p>type</p>	<p>p73:Fabbricato_Ord_Type</p>
<p>children</p>	<p>p73:Rendita p73:Utilizzo p73:GiorniPossesso p73:PercPossesso p73:CodiceCanone p73:CanoneLocazione p73:CasiParticolari p73:CasellaContinuazione p73:CodiceComune p73:OpzioneCedolare p73:CasellaCasiPartImu p73:AltriDati</p>

element **Modulo_Fabbricato_Type/FabbricatoAgev**

<p>diagram</p>	
<p>type</p>	<p>p73:Fabbricato_Agev_Type</p>

children	p73:NumeroRigoRiferimento p73:NumModuloRiferimento p73:DatiContratto p73:CasellaInf30Giorni p73:AnnoDichiarazioneIcilmu
----------	--

complexType **Modulo_Familiari_Type**

diagram	
children	p73:Coniuge p73:PrimoFiglio p73:Familiari

element **Modulo_Familiari_Type/Coniuge**

diagram	
type	p73:Dati_Coniuge_Type
children	p73:Tipo p73:CodiceFiscale p73:Mesi

element **Modulo_Familiari_Type/PrimoFiglio**

<p>diagram</p>	<p>The diagram shows a class p73:PrimoFiglio extending the class p73:Dati_Familiare_Type. The extension is highlighted in a yellow box and includes the following elements: p73:CodiceFiscale, p73:Mesi, p73:MesiMinore, p73:PercDetraz, p73:PercDetrazCon, p73:Affidamento, p73:MesiDetraz, p73:MesiDetraz21Anni, and p73:Tipo.</p>
<p>type</p>	<p>extension of p73:Dati_Familiare_Type</p>
<p>children</p>	<p>p73:CodiceFiscale p73:Mesi p73:MesiMinore p73:PercDetraz p73:PercDetrazCon p73:Affidamento p73:MesiDetraz p73:MesiDetraz21Anni p73:Tipo</p>

element **Modulo_Familiari_Type/PrimoFiglio/Tipo**

<p>diagram</p>	<p>The diagram shows a class p73:Tipo which is a restriction of the class DatoAN_Type.</p>						
<p>type</p>	<p>restriction of DatoAN_Type</p>						
<p>facets</p>	<table border="1"> <thead> <tr> <th>Kind</th> <th>Value</th> </tr> </thead> <tbody> <tr> <td>enumeration</td> <td>F</td> </tr> <tr> <td>enumeration</td> <td>D</td> </tr> </tbody> </table>	Kind	Value	enumeration	F	enumeration	D
Kind	Value						
enumeration	F						
enumeration	D						

element **Modulo_Familiari_Type/Familiari**

<p>diagram</p>	
<p>type</p>	<p>extension of p73:Dati_Familiare_Type</p>
<p>children</p>	<p>p73:CodiceFiscale p73:Mesi p73:MesiMinore p73:PercDetraz p73:PercDetrazCon p73:Affidamento p73:MesiDetraz p73:MesiDetraz21Anni p73:Tipo</p>

element **Modulo_Familiari_Type/Familiari/Tipo**

<p>diagram</p>									
<p>type</p>	<p>restriction of DatoAN_Type</p>								
<p>facets</p>	<table border="1"> <tr> <td>Kind</td> <td>Value</td> </tr> <tr> <td>enumeration</td> <td>F</td> </tr> <tr> <td>enumeration</td> <td>D</td> </tr> <tr> <td>enumeration</td> <td>A</td> </tr> </table>	Kind	Value	enumeration	F	enumeration	D	enumeration	A
Kind	Value								
enumeration	F								
enumeration	D								
enumeration	A								

complexType **Modulo_Lavoro_Dip_Type**

<p>diagram</p>	
<p>children</p>	<p>p73:LavoroDipendente p73:PremiRisultato p73:AltriRedditiAssLavDip</p>

element **Modulo_Lavoro_Dip_Type/LavoroDipendente**

diagram	
type	p73:Lavoro_Dipendente_Type
children	p73:TipologiaReddito p73:TipoContratto p73:Reddito p73:AltriRedditi

element **Modulo_Lavoro_Dip_Type/PremiRisultato**

diagram	
type	p73:Premi_Risultato_Modulo_Type
children	p73:TipoLimite p73:ImportoTassazOrdinaria p73:ImportoImpostaSostitutiva p73:RitenuteImpostaSostitutiva p73:Benefit p73:BenefitTassOrdinaria

element **Modulo_Lavoro_Dip_Type/AltriRedditiAssLavDip**

diagram	
---------	--

type	p73:Altri Redditi Ass Lav Type
children	p73:AssegnoDelConiuge p73:ImportoRedditoAssimilato p73:AltriDati

complexType **Modulo_Oneri_Type**



element **Modulo_Oneri_Type/SpeseDetrazioni**

<p>diagram</p>	
<p>type</p>	<p>p73:Detrazioni_Modulo_Type</p>
<p>children</p>	<p>p73:VeicoliDisabili p73:AcquistoCaniGuida p73:SpeseRateizzate p73:AltreSpese p73:SpeseLeasing</p>

element **Modulo_Oneri_Type/SpeseDeduzioni**

<p>diagram</p>	
<p>type</p>	<p>p73:Deduzioni_Modulo_Type</p>
<p>children</p>	<p>p73:AssegnoConiuge p73:AltriOneri p73:AcquistoCostruzioneAbitLocazione</p>

element **Modulo_Oneri_Type/InterventoRecuperoPatrimonioEdilizio**

<p>diagram</p>	
<p>type</p>	<p>p73:Intervento_Ricupero_Patrimonio_Edilizio_Type</p>
<p>children</p>	<p>p73:Anno p73:Periodo p73:CodiceFiscale p73:CasellaInterventiParticolari p73:CodiceSituazioniParticolari p73:MaggiorazioneSisma p73:Casella110 p73:Rate10 p73:Spesa p73:NOordinelmobile</p>

element **Modulo_Oneri_Type/DatiCatastaliRecuperoPatrimonioEdilizio**

<p>diagram</p>	
<p>type</p>	<p>p73:Sezione_Dati_Catastali_Recupero_Patrimonio_Edilizio_Type</p>
<p>children</p>	<p>p73:DatiCatastaliRecuperoPatrimonioEdilizio p73:DatiRegistrazioneAccatamentoRecuperoPatrimonio_Edilizio</p>

element **Modulo_Oneri_Type/InterventoRisparmioEnergetico**

<p>diagram</p>	
<p>type</p>	<p>p73:Intervento_Risparmio_Energetico_Type</p>
<p>children</p>	<p>p73:TipoIntervento p73:Anno p73:Periodo2013 p73:CasiParticolari p73:RideterminazioneRate p73:Casella110 p73:NumeroRata p73:Spesa p73:MaggiorazioneSisma</p>

element **Modulo_Oneri_Type/CanoniLocazione**

<p>diagram</p>	
<p>type</p>	<p>p73:Detrazioni_Canoni_Locazione_Type</p>
<p>children</p>	<p>p73:InquiliniAbitazionePrincipale p73:DipendentiTrasferiti</p>

element **Modulo_Oneri_Type/DatiAltreDetrazioni**

<p>diagram</p>	
<p>type</p>	<p>p73:Dati_Altre_Detrazioni_Modulo_Type</p>
<p>children</p>	<p>p73:AltreDetrazioni</p>

element **Modulo_Oneri_Type/SpeseArredo**

diagram	
type	p73:Spese_Arredo_Type
children	p73:NumeroRata p73:Importo

element **Modulo_Oneri_Type/SpeseArredoGiovani**

diagram	
type	p73:Spese_Arredo_Giovani_Coppie_Type
children	p73:Meno35Anni p73:Importo

element **Modulo_Oneri_Type/IvaAcquistoAbitazione**

diagram	
type	p73:Iva_Acquisto_Abitazione_Type
children	p73:NumeroRata p73:Importo

element **Modulo_Oneri_Type/SpesePaceContrRicarica**

diagram	
type	p73:Spese_Laurea_Ricarica_Type
children	p73:Codice p73:Anno p73:Importo

complexType **Modulo_PL_Type**

diagram	
children	p73:CredImpEestero

element **Modulo_PL_Type/CredImpEestero**

diagram	
type	p73:Cred_Imp_Estero_Type
children	p73:Anno p73:TotCredito p73:CreditoStato

complexType **Modulo_Terreno_Type**

diagram	
children	p73:Terreno

element **Modulo_Terreno_Type/Terreno**

<p>diagram</p>	
<p>type</p>	<p>p73:Terreno_Type</p>
<p>children</p>	<p>p73:RedDominicale p73:Titolo p73:RedAgrario p73:GiorniPossesso p73:PercPossesso p73:CanoneVincolistico p73:CasiParticolari p73:CasellaContinuazione p73:CasellalmuNonDovuta p73:CasellaColtivatoreDiretto</p>

complexType **Modulo_Ulteriori_Dati_Type**

<p>diagram</p>	
<p>children</p>	<p>p73:RedditoCampione p73:RedditoCampioneFranchi</p>

element **Modulo_Ulteriori_Dati_Type/RedditoCampione**

<p>diagram</p>	
<p>type</p>	<p>p73:Reddito_Campione_Type</p>
<p>children</p>	<p>p73:Codice p73:Importo</p>

element **Modulo_Ulteriori_Dati_Type/RedditoCampioneFranchi**

diagram	<p>The diagram shows a class <code>p73:RedditoCampioneFranchi</code> (dashed box) associated with a class <code>p73:Reddito_Campione_Franchi_Type</code> (yellow box). The association is represented by a line with an open arrowhead pointing to the type. Inside the type box, there are two attributes: <code>p73:Codice</code> and <code>p73:Importo</code>, each shown in a dashed box.</p>
type	p73:Reddito_Campione_Franchi_Type
children	p73:Codice p73:Importo

complexType **N_Rate_Type**

diagram	<p>The diagram shows a class <code>N_Rate_Type</code> (solid box) associated with a class <code>p73:Rate5</code> (dashed box). The association is represented by a line with an open arrowhead pointing to <code>p73:Rate5</code>.</p>
children	p73:Rate5

element **N_Rate_Type/Rate5**

diagram	<p>The diagram shows a class <code>p73:Rate5</code> (dashed box).</p>				
type	p73:Rate5_Type				
facets	<table border="0"> <tr> <td>Kind</td> <td>Value</td> </tr> <tr> <td>enumeration</td> <td>5</td> </tr> </table>	Kind	Value	enumeration	5
Kind	Value				
enumeration	5				

complexType **Oneri_Non_Abbattuti_Type**

<p>diagram</p>	
<p>children</p>	<p>p73:DetrazSpeseAssPersonale p73:DetrazErogazBiennaleVenezia p73:DetrazErogazSpettacolo p73:DetrazErogazSettoreMusicale p73:DeduzContributiPaesiSviluppo p73:DeduzOnlus p73:DetrazOspedaleGalliera p73:InteressiMutuiAgrari p73:DeduzTrust p73:InteressiMutuiAgrari2022</p>

element **Oneri_Non_Abbattuti_Type/DetrazSpeseAssPersonale**

<p>diagram</p>	
<p>type</p>	<p>DatoNP_Type</p>

element **Oneri_Non_Abbattuti_Type/DetrazErogazBiennaleVenezia**

<p>diagram</p>	
<p>type</p>	<p>DatoNP_Type</p>

element **Oneri_Non_Abbattuti_Type/DetrazErogazSpettacolo**

<p>diagram</p>	
<p>type</p>	<p>DatoNP_Type</p>

element Oneri_Non_Abbattuti_Type/DetrazErogazSettoreMusicale

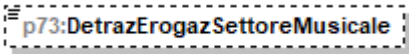
diagram	
type	DatoNP_Type

element Oneri_Non_Abbattuti_Type/DeduzContributiPaesiSviluppo

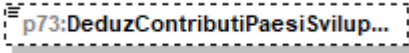
diagram	
type	DatoNP_Type

element Oneri_Non_Abbattuti_Type/DeduzOnlus

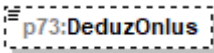
diagram	
type	DatoNP_Type

element Oneri_Non_Abbattuti_Type/DetrazOspedaleGalliera

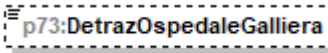
diagram	
type	DatoNP_Type

element Oneri_Non_Abbattuti_Type/InteressiMutuiAgrari

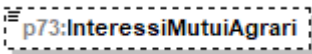
diagram	
type	DatoNP_Type

element Oneri_Non_Abbattuti_Type/DeduzTrust

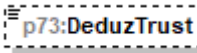
diagram	
type	DatoNP_Type

element Oneri_Non_Abbattuti_Type/InteressiMutuiAgrari2022

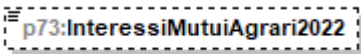
diagram	
type	DatoNP_Type

complexType **Oneri_Type**

diagram	
children	<p>p73:PrimoModulo p73:Modulo</p>

element **Oneri_Type/PrimoModulo**

diagram	
type	<p>p73:Primo Modulo Oneri Type</p>
children	<p>p73:SpeseDetrazioni p73:SpeseDeduzioni p73:InterventoRecuperoPatrimonioEdilizio p73:DatiCatastaliRecuperoPatrimonioEdilizio p73:InterventoRisparmioEnergetico p73:CanoniLocazione p73:DatiAltreDetrazioni p73:OneriNonAbbattuti p73:SpeseArredo p73:SpeseArredoGiovani p73:IvaAcquistoAbitazione p73:SpesePaceContrRicarica</p>

element **Oneri_Type/Modulo**

<p>diagram</p>	
<p>type</p>	<p>p73:Modulo Oneri Type</p>
<p>children</p>	<p>p73:SpeseDetrazioni p73:SpeseDeduzioni p73:InterventoRecuperoPatrimonioEdilizio p73:DatiCatastaliRecuperoPatrimonioEdilizio p73:InterventoRisparmioEnergetico p73:CanoniLocazione p73:DatiAltreDetrazioni p73:SpeseArredo p73:SpeseArredoGiovani p73:IvaAcquistoAbitazione p73:SpesePaceContrRicarica</p>

complexType **Opzione_Produttivita_Type**

<p>diagram</p>	
----------------	--

complexType **Periodo_Di_Lavoro_Type**

<p>diagram</p>	
<p>children</p>	<p>p73:GiorniLavoroDipendente p73:GiorniPensione</p>

element **Periodo_Di_Lavoro_Type/GiorniLavoroDipendente**

diagram	
type	DatoGA_Type

element **Periodo_Di_Lavoro_Type/GiorniPensione**

diagram	
type	DatoGA_Type

complexType **Premi_Risultato_Modulo_Type**

diagram	
children	p73:TipoLimite p73:ImportoTassazOrdinaria p73:ImportoImpostaSostitutiva p73:RitenuteImpostaSostitutiva p73:Benefit p73:BenefitTassOrdinaria

element **Premi_Risultato_Modulo_Type/TipoLimite**

diagram							
type	restriction of DatoN1_Type						
facets	<table border="1"> <thead> <tr> <th>Kind</th> <th>Value</th> </tr> </thead> <tbody> <tr> <td>enumeration</td> <td>1</td> </tr> <tr> <td>enumeration</td> <td>2</td> </tr> </tbody> </table>	Kind	Value	enumeration	1	enumeration	2
Kind	Value						
enumeration	1						
enumeration	2						

element **Premi_Risultato_Modulo_Type/ImportoTassazOrdinaria**

diagram	
type	DatoNP_Type

element **Premi_Risultato_Modulo_Type/ImportoImpostaSostitutiva**

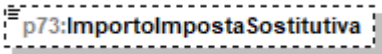
diagram	
type	DatoNP_Type

element **Premi_Risultato_Modulo_Type/RitenuteImpostaSostitutiva**

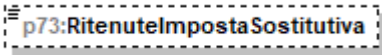
diagram	
type	DatoNP_Type

element **Premi_Risultato_Modulo_Type/Benefit**

diagram	
type	DatoNP_Type

element **Premi_Risultato_Modulo_Type/BenefitTassOrdinaria**

diagram	
type	DatoNP_Type

complexType **Premi_Risultato_Type**

<p>diagram</p>	
<p>type</p>	<p>extension of p73:Premi_Risultato_Modulo_Type</p>
<p>children</p>	<p>p73:TipoLimite p73:ImportoTassazOrdinaria p73:ImportoImpostaSostitutiva p73:RitenuteImpostaSostitutiva p73:Benefit p73:BenefitTassOrdinaria p73:TassazOrdinaria p73:TassazSostitutiva p73:AssenzaRequisiti</p>

element **Premi_Risultato_Type/TassazOrdinaria**

<p>diagram</p>	
<p>type</p>	<p>DatoCB_Type</p>

element **Premi_Risultato_Type/TassazSostitutiva**

<p>diagram</p>	
<p>type</p>	<p>DatoCB_Type</p>

element **Premi_Risultato_Type/AssenzaRequisiti**

<p>diagram</p>	
<p>type</p>	<p>DatoCB_Type</p>

complexType **Primo_Modulo_Acconti_Ritenute_Type**

<p>diagram</p>	
<p>children</p>	<p>p73:Accontilrpef p73:AltreRitenute p73:Eccedenze p73:EccedenzeOltreAnno p73:RitenuteAccontiSospesi p73:MisuraAcconti p73:EsenzioneAddComunale p73:Dati730Integrativo p73:AccontiAltriDati p73:LocazioniBrevi</p>

element **Primo_Modulo_Acconti_Ritenute_Type/Accontilrpef**

<p>diagram</p>	
<p>type</p>	<p>p73:Acconti_Irpef_Anno_Imposta_Type</p>
<p>children</p>	<p>p73:PrimaRataAccontolrpef p73:SecondaRataAccontolrpef p73:AccontoAddComunale p73:PrimaRataAccontoCedolare p73:SecondaRataAccontoCedolare</p>

element **Primo Modulo Acconti Ritenute Type/AltreRitenute**

<p>diagram</p>	
<p>type</p>	<p>p73:Altre_Ritenute_Type</p>
<p>children</p>	<p>p73:Codice p73:AltreRitenuteIrpef p73:AddizionaleRegionale p73:AddizionaleComunale p73:AddRegionaleIrpefAttivitaSport p73:AddComunaleIrpefAttivitaSport p73:IrpefLavoriSocialmenteUtili p73:AddRegionaleIrpefLavoriSoc Utili</p>

element **Primo Modulo Acconti Ritenute Type/Eccedenze**

<p>diagram</p>	
<p>type</p>	<p>p73:Eccedenze_Type</p>
<p>children</p>	<p>p73:lrpef p73:lrpefCompF24 p73:SostitutivaQuadroRT p73:SostitutivaQuadroRTcompF24 p73:CedolareSecca p73:CedolareSeccaCompF24 p73:CodiceRegione p73:AddRegionalelrpef p73:AddRegionalelrpefCompF24 p73:CodiceCatastaleComune p73:AddComunalelrpef p73:AddComunalelrpefF24 p73:PremioRisultato p73:PremioRisultatoCompF24</p>

element **Primo_Modulo_Acconti_Ritenute_Type/EccedenzeOltreAnno**

<p>diagram</p>	
<p>type</p>	<p>p73:Eccedenze Oltre Anno Type</p>
<p>children</p>	<p>p73:Anno p73:Irpef p73:SostitutivaQuadroRT p73:CedolareSecca p73:CodiceRegione p73:AddRegionaleIrpef p73:CodiceCatastaleComune p73:AddComunaleIrpef p73:ImpostaSostitutiva</p>

element **Primo_Modulo_Acconti_Ritenute_Type/RitenuteAccontiSospesi**

<p>diagram</p>	
<p>type</p>	<p>p73:Ritenute Acconti Sospesi Type</p>
<p>children</p>	<p>p73:CodiceEvento p73:Irpef p73:AddRegionaleIrpef p73:AddComunaleIrpef p73:SostitutivaPremi p73:CedolareSecca p73:SostitutivaRita</p>

element **Primo_Modulo_Acconti_Ritenute_Type/MisuraAcconti**

<p>diagram</p>	
<p>type</p>	<p>p73:Misura_Acconti_Type</p>
<p>children</p>	<p>p73:IrpefMisuralInferiore p73:AddComunaleMisuralInferiore p73:CedolareSeccaMisuralInferiore p73:NumeroRate</p>

element **Primo_Modulo_Acconti_Ritenute_Type/EsenzioneAddComunale**

<p>diagram</p>	
<p>type</p>	<p>p73:Esenzione_Add_Comunale_Type</p>
<p>children</p>	<p>p73:SogliaEsenzioneSaldo p73:SogliaEsenzioneAcconto</p>

element **Primo_Modulo_Acconti_Ritenute_Type/Dati730Integrativo**

<p>diagram</p>	
<p>type</p>	<p>p73:Dati_730_Integrativo_Type</p>
<p>children</p>	<p>p73:Rimborso p73:Credito</p>

element **Primo_Modulo_Acconti_Ritenute_Type/AccontiAltriDati**

<p>diagram</p>	
<p>type</p>	<p>p73:Acconti_Altri_Dati_Type</p>
<p>children</p>	<p>p73:IncapientiDetrazioneFigli p73:IncapientiDetrazioneLocazione p73:RestituzioneBonusFiscale p73:RestituzioneBonusStraordinario p73:Pignoramento</p>

element **Primo_Modulo_Acconti_Ritenute_Type/LocazioniBrevi**

<p>diagram</p>	
<p>type</p>	<p>p73:Locazioni_Brevi_Type</p>
<p>children</p>	<p>p73:Ritenute</p>

complexType **Primo_Modulo_Crediti_Imposta_Type**

<p>diagram</p>	
----------------	--

children	p73:CreditiImpostaFabbricati p73:CreditiImpostaFondiPensione p73:CreditiImpostaRedditiEsteri p73:CreditoPrimaCasaSismaAbruzzo p73:CreditoAltriSismaAbruzzo p73:CreditoPrimaCasaU36 p73:CreditoErogazioniCultura p73:CreditoNegoziazione p73:AltriCreditiImposta
----------	---

element **Primo_Modulo_Crediti_Imposta_Type/CreditiImpostaFabbricati**

diagram	
type	p73:Crediti Imposta Fabbricati Type
children	p73:ResiduoFabbricati p73:CanoniLocazioneNonPercepiti

element **Primo_Modulo_Crediti_Imposta_Type/CreditiImpostaFondiPensione**

diagram	
type	extension of p73:Crediti Imposta Fondi Pensione Type
children	p73:AnnoAnticipazione p73:Reintegro p73:SommaReintegrata p73:CreditoAnno p73:ResiduoPrecedenteDichiarazione p73:DiCuiCompensatoF24

element **Primo_Modulo_Crediti_Imposta_Type/CreditiImpostaFondiPensione/ResiduoPrecedenteDichiarazione**

diagram	
type	DatoNP Type

element **Primo_Modulo_Crediti_Imposta_Type/CreditiImpostaFondiPensione/DiCuiCompensatoF24**

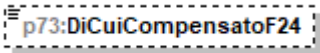
diagram	
type	DatoNP_Type

element **Primo_Modulo_Crediti_Imposta_Type/CreditiImpostaRedditiEsteri**

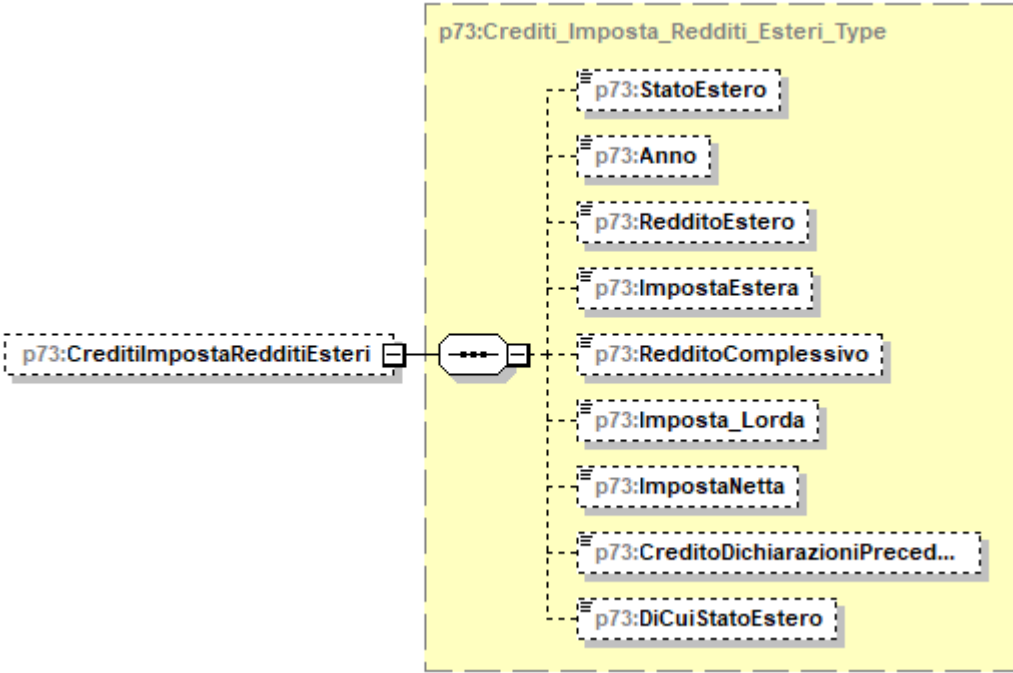
diagram	
type	p73:Crediti_Imposta_Redditi_Esteri_Type
children	p73:StatoEestero p73:Anno p73:RedditoEestero p73:ImpostaEстера p73:RedditoComplessivo p73:Imposta_Lorda p73:ImpostaNetta p73:CreditoDichiarazioniPrecedenti p73:DiCuiStatoEestero

element **Primo_Modulo_Crediti_Imposta_Type/CreditoPrimaCasaSismaAbruzzo**

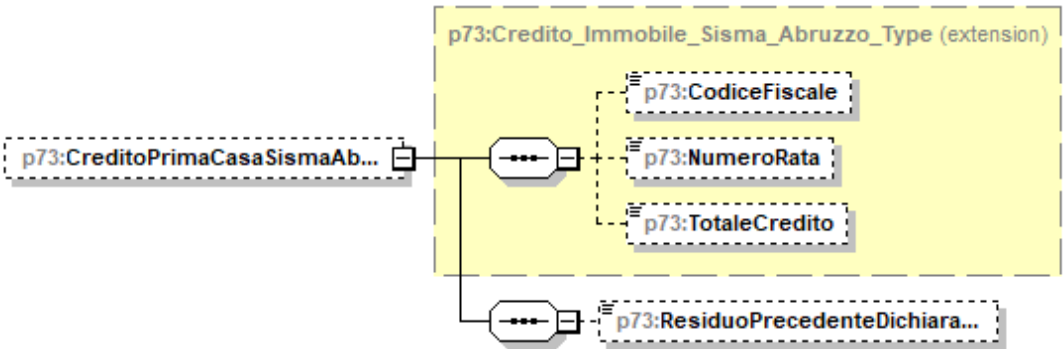
diagram	
type	extension of p73:Credito_Immobile_Sisma_Abruzzo_Type
children	p73:CodiceFiscale p73:NumeroRata p73:TotaleCredito p73:ResiduoPrecedenteDichiarazione

element

Primo_Modulo_Crediti_Imposta_Type/CreditoPrimaCasaSismaAbruzzo/ResiduoPrecedenteDichiarazione

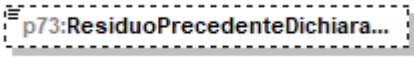
diagram	
type	DatoNP_Type

element **Primo_Modulo_Crediti_Imposta_Type/CreditoAltriSismaAbruzzo**

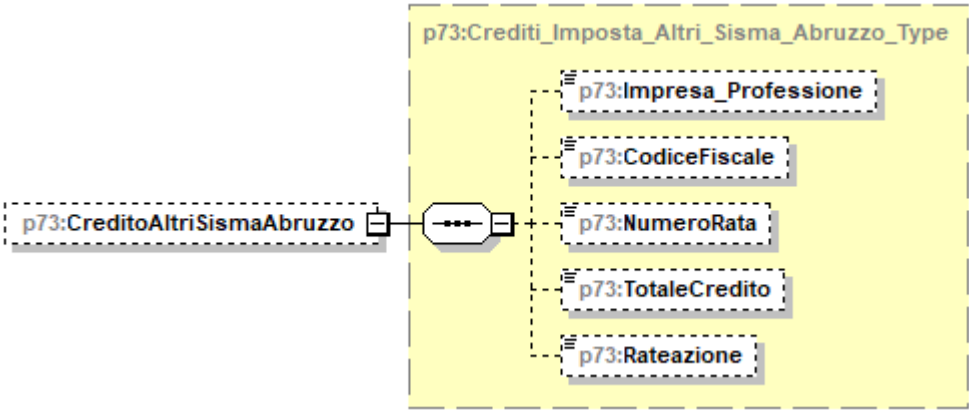
diagram	
type	p73:Crediti_Imposta_Altri_Sisma_Abruzzo_Type
children	p73:Impresa_Professione p73:CodiceFiscale p73:NumeroRata p73:TotaleCredito p73:Rateazione

element **Primo_Modulo_Crediti_Imposta_Type/CreditoPrimaCasaU36**

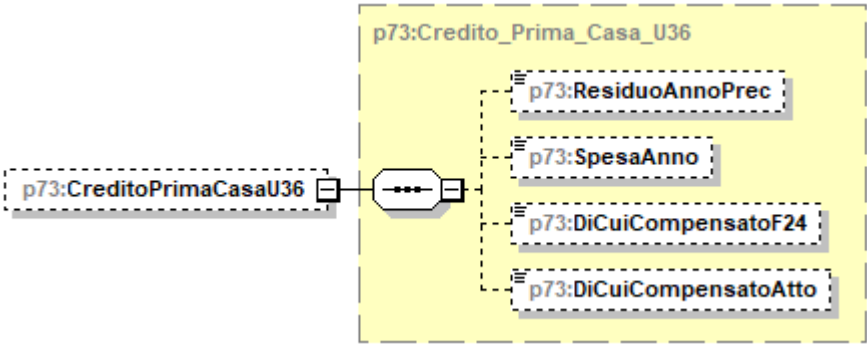
diagram	
type	p73:Credito_Prima_Casa_U36
children	p73:ResiduoAnnoPrec p73:SpesaAnno p73:DiCuiCompensatoF24 p73:DiCuiCompensatoAtto

element **Primo Modulo Crediti Imposta Type/CreditoErogazioniCultura**

<p>diagram</p>	
<p>type</p>	<p>p73:Credito_Erogazioni_Cultura_Type</p>
<p>children</p>	<p>p73:SpesaAnno p73:ResiduoAnnoPrec p73:RataAnnoPrec p73:RataDueAnniPrec</p>

element **Primo Modulo Crediti Imposta Type/CreditoNegoziazione**

<p>diagram</p>	
<p>type</p>	<p>p73:Credito_Negoziatore_Type</p>
<p>children</p>	<p>p73:CreditoSpettante p73:ResiduoAnnoPrec p73:DiCuiCompensatoF24</p>

element **Primo Modulo Crediti Imposta Type/AltriCreditiImposta**

<p>diagram</p>	
<p>type</p>	<p>p73:Altri_Crediti_Imposta_Type</p>
<p>children</p>	<p>p73:Codice p73:Importo p73:ResiduoAnnoPrec p73:RataDueAnniPrec p73:DiCuiCompensatoF24</p>

complexType **Primo_Modulo_Familiari_Type**

<p>diagram</p>	
<p>type</p>	<p>extension of p73:Modulo_Familiari_Type</p>
<p>children</p>	<p>p73:Coniuge p73:PrimoFiglio p73:Familiari p73:PercUlteriore p73:FigliAffidoPread</p>

element **Primo_Modulo_Familiari_Type/PercUlteriore**

<p>diagram</p>	
<p>type</p>	<p>DatoPC_Type</p>

element **Primo_Modulo_Familiari_Type/FigliAffidoPread**

<p>diagram</p>	
<p>type</p>	<p>DatoNP_Type</p>

complexType **Primo_Modulo_Lavoro_Dip_Type**

<p>diagram</p>	
<p>children</p>	<p>p73:LavoroDipendente p73:PremiRisultato p73:PeriodoLavoro p73:AltriRedditiAssLavDip p73:RitenuteLavoroDipendente p73:RiduzionePressioneFiscale p73:CasellaCasiParticolari p73:StatoEstero p73:CompartoSicurezza</p>

element **Primo_Modulo_Lavoro_Dip_Type/LavoroDipendente**

<p>diagram</p>	
<p>type</p>	<p>p73:Lavoro Dipendente Type</p>
<p>children</p>	<p>p73:TipologiaReddito p73:TipoContratto p73:Reddito p73:AltriRedditi</p>

element **Primo Modulo Lavoro Dip_Type/PremiRisultato**

<p>diagram</p>	
<p>type</p>	<p>p73:Premi_Risultato_Type</p>
<p>children</p>	<p>p73:TipoLimite p73:ImportoTassazOrdinaria p73:ImportoImpostaSostitutiva p73:RitenuteImpostaSostitutiva p73:Benefit p73:BenefitTassOrdinaria p73:TassazOrdinaria p73:TassazSostitutiva p73:AssenzaRequisiti</p>

element **Primo Modulo Lavoro Dip_Type/PeriodoLavoro**

<p>diagram</p>	
<p>type</p>	<p>p73:Periodo_Di_Lavoro_Type</p>
<p>children</p>	<p>p73:GiorniLavoroDipendente p73:GiorniPensione</p>

element **Primo Modulo Lavoro Dip Type/AltriRedditiAssLavDip**

<p>diagram</p>	
<p>type</p>	<p>p73:Altri_Redditi_Ass_Lav_Type</p>
<p>children</p>	<p>p73:AssegnoDelConiuge p73:ImportoRedditoAssimilato p73:AltriDati</p>

element **Primo Modulo Lavoro Dip Type/RitenuteLavoroDipendente**

<p>diagram</p>	
<p>type</p>	<p>p73:Ritenute_Lavoro_Dip_Type</p>
<p>children</p>	<p>p73:Ritlrpef p73:RitRita p73:RitAddRegionale p73:RitAccAddComunale p73:RitSaldoAddComunale p73:RitAccAddComAnnoPres</p>

element **Primo Modulo Lavoro Dip Type/RiduzionePressioneFiscale**

<p>diagram</p>	
<p>type</p>	<p>p73:Riduzione_Pressione_Type</p>

children	p73:CodiceTrattamento p73:TrattamentoErogato p73:EsenzioneRicercatori p73:EsenzioneImpatriati
----------	---

element **Primo_Modulo_Lavoro_Dip_Type/CasellaCasiParticolari**

diagram																									
type	restriction of DatoNP_Type																								
facets	<table border="1"> <thead> <tr> <th>Kind</th> <th>Value</th> </tr> </thead> <tbody> <tr><td>enumeration</td><td>2</td></tr> <tr><td>enumeration</td><td>4</td></tr> <tr><td>enumeration</td><td>6</td></tr> <tr><td>enumeration</td><td>8</td></tr> <tr><td>enumeration</td><td>9</td></tr> <tr><td>enumeration</td><td>10</td></tr> <tr><td>enumeration</td><td>11</td></tr> <tr><td>enumeration</td><td>12</td></tr> <tr><td>enumeration</td><td>13</td></tr> <tr><td>enumeration</td><td>14</td></tr> <tr><td>enumeration</td><td>15</td></tr> </tbody> </table>	Kind	Value	enumeration	2	enumeration	4	enumeration	6	enumeration	8	enumeration	9	enumeration	10	enumeration	11	enumeration	12	enumeration	13	enumeration	14	enumeration	15
Kind	Value																								
enumeration	2																								
enumeration	4																								
enumeration	6																								
enumeration	8																								
enumeration	9																								
enumeration	10																								
enumeration	11																								
enumeration	12																								
enumeration	13																								
enumeration	14																								
enumeration	15																								

element **Primo_Modulo_Lavoro_Dip_Type/StatoEstero**

diagram	
type	DatoAN_Type

element **Primo_Modulo_Lavoro_Dip_Type/CompartoSicurezza**

diagram	
type	p73:Comparto_Sicurezza_Type
children	p73:FruitaOrdinaria p73:NonFruitaOrdinaria p73:FruitaSeparata

complexType **Primo_Modulo_Oneri_Type**

<p>diagram</p>	
<p>children</p>	<p>p73:SpeseDetrazioni p73:SpeseDeduzioni p73:InterventoRecuperoPatrimonioEdilizio p73:DatiCatastaliRecuperoPatrimonioEdilizio p73:InterventoRisparmioEnergetico p73:CanoniLocazione p73:DatiAltreDetrazioni p73:OneriNonAbbattuti p73:SpeseArredo p73:SpeseArredoGiovani p73:IvaAcquistoAbitazione p73:SpesePaceContrRicarica</p>

element **Primo Modulo Oneri Type/SpeseDetrazioni**

<p>diagram</p>	
<p>type</p>	<p>p73:Detrazioni_Type</p>
<p>children</p>	<p>p73:CasellaRateazione p73:SpeseDeterminatePatologie p73:SpeseSanitarie p73:SpeseFamNonACarico p73:SpeseSanitarieDisabili p73:VeicoliDisabili p73:AcquistoCaniGuida p73:SpeseRateizzate p73:MutuiAbPrincipaleAnte p73:MutuiAbPrincipalePost p73:AltreSpese p73:SpeseLeasing</p>

element **Primo Modulo Oneri Type/SpeseDeduzioni**

<p>diagram</p>	
<p>type</p>	<p>p73:Deduzioni_Type</p>
<p>children</p>	<p>p73:ContributiPrevAss p73:AssegnoConiuge p73:ContributiColf p73:ErogazioniIstituzioniReligiose p73:SpesePortatoriHandicap p73:AltriOneri p73:DeducibilitaOrdinaria p73:LavoratoriPrimaOccupazione p73:FondiInSquilibrioFinanziario p73:FamiliariACarico p73:AcquistoCostruzioneAbitL... p73:RestituzioneSomme p73:ErogazioniOnlus</p>

element **Primo_Modulo_Oneri_Type/InterventoRecuperoPatrimonioEdilizio**

<p>diagram</p>	
<p>type</p>	<p>p73:Intervento Recupero Patrimonio Edilizio Type</p>
<p>children</p>	<p>p73:Anno p73:Periodo p73:CodiceFiscale p73:CasellaInterventiParticolari p73:CodiceSituazioniParticolari p73:MaggiorazioneSisma p73:Casella110 p73:Rate10 p73:Spesa p73:NOordinelmobile</p>

element **Primo_Modulo_Oneri_Type/DatiCatastaliRecuperoPatrimonioEdilizio**

<p>diagram</p>	
<p>type</p>	<p>p73:Sezione Dati Catastali Recupero Patrimonio Edilizio Type</p>
<p>children</p>	<p>p73:DatiCatastaliRecuperoPatrimonioEdilizio p73:DatiRegistrazioneAccatamentoRecuperoPatrimonio Edilizio</p>

element **Primo_Modulo_Oneri_Type/InterventoRisparmioEnergetico**

<p>diagram</p>	
<p>type</p>	<p>p73:Intervento_Risparmio_Energetico_Type</p>
<p>children</p>	<p>p73:TipoIntervento p73:Anno p73:Periodo2013 p73:CasiParticolari p73:RideterminazioneRate p73:Casella110 p73:NumeroRata p73:Spesa p73:MaggiorazioneSisma</p>

element **Primo_Modulo_Oneri_Type/CanoniLocazione**

<p>diagram</p>	
<p>type</p>	<p>p73:Detrazioni_Canoni_Locazione_Type</p>
<p>children</p>	<p>p73:InquiliniAbitazionePrincipale p73:DipendentiTrasferiti</p>

element **Primo_Modulo_Oneri_Type/DatiAltreDetrazioni**

<p>diagram</p>	
<p>type</p>	<p>p73:Dati_Altre_Detrazioni_Type</p>

children	p73:SpeseCaniGuida p73:AltreDetrazioni
----------	--

element **Primo_Modulo_Oneri_Type/OneriNonAbbattuti**

diagram	
type	p73:Oneri Non Abbattuti Type
children	p73:DetrazSpeseAssPersonale p73:DetrazErogazBiennaleVenezia p73:DetrazErogazSpettacolo p73:DetrazErogazSettoreMusicale p73:DeduzContributiPaesiSviluppo p73:DeduzOnlus p73:DetrazOspedaleGalliera p73:InteressiMutuiAgrari p73:DeduzTrust p73:InteressiMutuiAgrari2022

element **Primo_Modulo_Oneri_Type/SpeseArredo**

diagram	
type	p73:Spese Arredo Type
children	p73:NumeroRata p73:Importo

element **Primo_Modulo_Oneri_Type/SpeseArredoGiovani**

diagram	
type	p73:Spese_Arredo_Giovani_Coppie_Type
children	p73:Meno35Anni p73:Importo

element **Primo_Modulo_Oneri_Type/IvaAcquistoAbitazione**

diagram	
type	p73:Iva_Acquisto_Abitazione_Type
children	p73:NumeroRata p73:Importo

element **Primo_Modulo_Oneri_Type/SpesePaceContrRicarica**

diagram	
type	p73:Spese_Laurea_Ricarica_Type
children	p73:Codice p73:Anno p73:Importo

complexType **Primo_Modulo_PL_Type**

diagram	
children	p73:Prospetto p73:ProspettoRideterminato

element **Primo_Modulo_PL_Type/Prospetto**

<p>diagram</p>	
<p>type</p>	<p>extension of p73:Prospetto_Type</p>
<p>children</p>	<p>p73:RiepilogoRedditi p73:ImpostaLorda p73:DetrazioniCrediti p73:ImpostaNetta p73:Addizionali p73:CedolareSecca p73:LiquidazioneImposte p73:AltriDati p73:CredImpEstero p73:DatiCreditiF24</p>

element **Primo Modulo_PL_Type/Prospetto/Addizionali**

<p>diagram</p>	
<p>type</p>	<p>p73:Addizionali_Type</p>
<p>children</p>	<p>p73:Imponibile p73:AddRegDovuta p73:AddRegCertif p73:EccedenzaAddReg p73:AddComDovuta p73:AddComCertif p73:EccedenzaAddCom p73:AccontoAddCom p73:AccontoAddComCertif</p>

element **Primo Modulo_PL_Type/Prospetto/CedolareSecca**

<p>diagram</p>	
<p>type</p>	<p>p73:Cedolare_Secca_Type</p>
<p>children</p>	<p>p73:CedolareDovuta p73:EccedenzaCedolareSecca p73:AccontoCedolare</p>

element **Primo_Modulo_PL_Type/Prospetto/LiquidazioneImposte**

<p>diagram</p>	
<p>children</p>	<p>p73:EsitoIrpef p73:EsitoAddRegionale p73:EsitoAddComunale p73:PrimaRataAcclrpef p73:SecondaRataAcclrpef p73:AccontoTassSep p73:AccontoAddComunale p73:ImpostaSostitutiva p73:EsitoCedolareSecca p73:PrimaRataAccCedolare p73:SecondaRataAccCedolare</p>

element **Primo_Modulo_PL_Type/Prospetto/LiquidazioneImposte/EsitoIrpef**

<p>diagram</p>	
<p>type</p>	<p>p73:Esito_Liquidazione_Type</p>
<p>children</p>	<p>p73:Credito p73:Debito</p>

element **Primo_Modulo_PL_Type/Prospetto/LiquidazioneImposte/EsitoAddRegionale**

diagram	
type	extension of p73:Esito_Liquidazione_Type
children	p73:Credito p73:Debito p73:CodAddReg

element **Primo_Modulo_PL_Type/Prospetto/LiquidazioneImposte/EsitoAddRegionale/CodAddReg**

diagram																																													
type	Codice Regione Type																																												
facets	<table border="1"> <thead> <tr> <th>Kind</th> <th>Value</th> </tr> </thead> <tbody> <tr><td>enumeration</td><td>1</td></tr> <tr><td>enumeration</td><td>2</td></tr> <tr><td>enumeration</td><td>3</td></tr> <tr><td>enumeration</td><td>4</td></tr> <tr><td>enumeration</td><td>5</td></tr> <tr><td>enumeration</td><td>6</td></tr> <tr><td>enumeration</td><td>7</td></tr> <tr><td>enumeration</td><td>8</td></tr> <tr><td>enumeration</td><td>9</td></tr> <tr><td>enumeration</td><td>10</td></tr> <tr><td>enumeration</td><td>11</td></tr> <tr><td>enumeration</td><td>12</td></tr> <tr><td>enumeration</td><td>13</td></tr> <tr><td>enumeration</td><td>14</td></tr> <tr><td>enumeration</td><td>15</td></tr> <tr><td>enumeration</td><td>16</td></tr> <tr><td>enumeration</td><td>17</td></tr> <tr><td>enumeration</td><td>18</td></tr> <tr><td>enumeration</td><td>19</td></tr> <tr><td>enumeration</td><td>20</td></tr> <tr><td>enumeration</td><td>21</td></tr> </tbody> </table>	Kind	Value	enumeration	1	enumeration	2	enumeration	3	enumeration	4	enumeration	5	enumeration	6	enumeration	7	enumeration	8	enumeration	9	enumeration	10	enumeration	11	enumeration	12	enumeration	13	enumeration	14	enumeration	15	enumeration	16	enumeration	17	enumeration	18	enumeration	19	enumeration	20	enumeration	21
Kind	Value																																												
enumeration	1																																												
enumeration	2																																												
enumeration	3																																												
enumeration	4																																												
enumeration	5																																												
enumeration	6																																												
enumeration	7																																												
enumeration	8																																												
enumeration	9																																												
enumeration	10																																												
enumeration	11																																												
enumeration	12																																												
enumeration	13																																												
enumeration	14																																												
enumeration	15																																												
enumeration	16																																												
enumeration	17																																												
enumeration	18																																												
enumeration	19																																												
enumeration	20																																												
enumeration	21																																												

element **Primo_Modulo_PL_Type/Prospetto/LiquidazioneImposte/EsitoAddComunale**

diagram	
---------	--

type	extension of p73:Esito Liquidazione Type
children	p73:Credito p73:Debito p73:CodiceAddCom

element **Primo_Modulo_PL_Type/Prospetto/LiquidazioneImposte/EsitoAddComunale/CodiceAddCom**

diagram	
type	DatoAN Type

element **Primo_Modulo_PL_Type/Prospetto/LiquidazioneImposte/PrimaRataAcclrpef**

diagram	
type	DatoNP Type

element **Primo_Modulo_PL_Type/Prospetto/LiquidazioneImposte/SecondaRataAcclrpef**

diagram	
type	DatoNP Type

element **Primo_Modulo_PL_Type/Prospetto/LiquidazioneImposte/AccontoTassSep**

diagram	
type	p73:Debito Type
children	p73:NonVersare p73:ImportoDaTrattenere

element **Primo_Modulo_PL_Type/Prospetto/LiquidazioneImposte/AccontoAddComunale**

diagram	
children	p73:CodiceAddComAcconto p73:AccontoAddCom

element

Primo_Modulo_PL_Type/Prospetto/LiquidazioneImposte/AcontoAddComunale/CodiceAddComAcconto

diagram	
type	DatoAN_Type

element

Primo_Modulo_PL_Type/Prospetto/LiquidazioneImposte/AcontoAddComunale/AcontoAddCom

diagram	
type	DatoNP_Type

element **Primo_Modulo_PL_Type/Prospetto/LiquidazioneImposte/ImpostaSostitutiva**

diagram	
type	p73:Debito_Type
children	p73:NonVersare p73:ImportoDaTrattenere

element **Primo_Modulo_PL_Type/Prospetto/LiquidazioneImposte/EsitoCedolareSecca**

diagram	
type	p73:Esito_Liquidazione_Type
children	p73:Credito p73:Debito

element **Primo_Modulo_PL_Type/Prospetto/LiquidazioneImposte/PrimaRataAccCedolare**

diagram	
type	DatoNP_Type

element **Primo_Modulo_PL_Type/Prospetto/LiquidazioneImposte/SecondaRataAccCedolare**

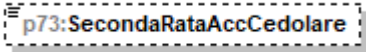
<p>diagram</p>	
<p>type</p>	<p>DatoNP_Type</p>

element **Primo_Modulo_PL_Type/Prospetto/AltriDati**



type	extension of p73:Altri_Dati_Type
children	p73:ResiduoCreditoErogazioneCultura p73:ResiduoCreditoPrimaCasa p73:ResiduoCreditoSisma p73:ResiduoCreditoFondiPensione p73:TotSpeseSanitarieRateizzate p73:RedditoAgevolazioniFiscali p73:RedditoComplessivoAcconto p73:RigoDifferenzaAcconto p73:AccontiCompensatiIntern p73:RedditiFondariNonImponibili p73:RedditoAbitazionePrincipalePertinenze p73:ResiduoDeduzioneSommeRestituite p73:ResiduoCreditoNegoziazione p73:ResiduoOnlus p73:ResiduoPrimaCasaU36 p73:ResiduoErogazioniSportive p73:ResiduoBonificaAmbientale p73:ResiduoCreditoOccupazione p73:ResiduoErogazioniScuola p73:ResiduoCreditoVideosorveglianza p73:ResiduoCreditoSanificazione p73:ResiduoCreditoDepuratori p73:ResiduoCreditoSocialBonus p73:ResiduoCreditoAttivitaFisica p73:ResiduoCreditoEnergia p73:ResiduoCreditoITS p73:ResiduoCreditoITSAItaDis p73:ResiduoCreditoMediazioni p73:RataSocialBonus p73:RataBonificaAmbientale p73:CreditoErogazioneCultura

element **Primo_Modulo_PL_Type/Prospetto/AltriDati/ResiduoCreditoErogazioneCultura**

diagram	
type	DatoNP_Type

element **Primo_Modulo_PL_Type/Prospetto/AltriDati/ResiduoCreditoPrimaCasa**

diagram	
type	DatoNP_Type

element **Primo_Modulo_PL_Type/Prospetto/AltriDati/ResiduoCreditoSisma**

diagram	
type	DatoNP_Type

element **Primo_Modulo_PL_Type/Prospetto/AltriDati/ResiduoCreditoFondiPensione**

diagram	
type	DatoNP_Type

element **Primo_Modulo_PL_Type/Prospetto/AltriDati/TotSpeseSanitarieRateizzate**

diagram	
type	DatoNP_Type

element **Primo Modulo_PL_Type/Prospetto/AltriDati/RedditoAgevolazioniFiscali**

diagram	
type	DatoNP_Type

element **Primo Modulo_PL_Type/Prospetto/AltriDati/RedditoComplessivoAcconto**

diagram	
type	DatoNP_Type

element **Primo Modulo_PL_Type/Prospetto/AltriDati/RigoDifferenzaAcconto**

diagram	
type	DatoNU_Type

element **Primo Modulo_PL_Type/Prospetto/AltriDati/AcontiCompensatiIntern**

diagram	
type	p73:Acoonti_Compensati_Intern_Type
children	p73:PrimaRatalrpef p73:AddizionaleComunale p73:PrimaRataCedolare

element **Primo Modulo_PL_Type/Prospetto/AltriDati/RedditiFondiariNonImponibili**

diagram	
type	DatoNP_Type

element **Primo Modulo_PL_Type/Prospetto/AltriDati/RedditoAbitazionePrincipalePertinenze**

diagram	
type	DatoNP_Type

element **Primo_Modulo_PL_Type/Prospetto/AltriDati/ResiduoDeduzioneSommeRestituite**

diagram	
type	DatoNP_Type

element **Primo_Modulo_PL_Type/Prospetto/AltriDati/ResiduoCreditoNegoziazione**

diagram	
type	DatoNP_Type

element **Primo_Modulo_PL_Type/Prospetto/AltriDati/ResiduoOnlus**

diagram	
type	p73:Residuo_Onlus_Type
children	p73:ResiduoTreAnniPrec p73:ResiduoDueAnniPrec p73:ResiduoAnnoPrec p73:ResiduoAnno

element **Primo_Modulo_PL_Type/Prospetto/AltriDati/ResiduoPrimaCasaU36**

diagram	
type	DatoNP_Type

element **Primo_Modulo_PL_Type/Prospetto/AltriDati/ResiduoErogazioniSportive**

diagram	
type	DatoNP_Type

element **Primo_Modulo_PL_Type/Prospetto/AltriDati/ResiduoBonificaAmbientale**

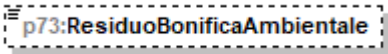
diagram	
type	DatoNP_Type

element **Primo_Modulo_PL_Type/Prospetto/AltriDati/ResiduoCreditoOccupazione**

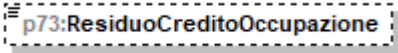
diagram	
type	DatoNP_Type

element **Primo_Modulo_PL_Type/Prospetto/AltriDati/ResiduoErogazioniScuola**

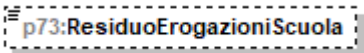
diagram	
type	DatoNP_Type

element **Primo_Modulo_PL_Type/Prospetto/AltriDati/ResiduoCreditoVideosorveglianza**

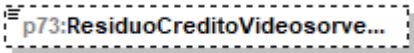
diagram	
type	DatoNP_Type

element **Primo_Modulo_PL_Type/Prospetto/AltriDati/ResiduoCreditoSanificazione**

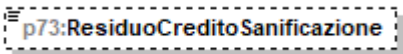
diagram	
type	DatoNP_Type

element **Primo_Modulo_PL_Type/Prospetto/AltriDati/ResiduoCreditoDepuratori**

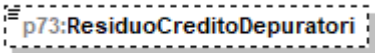
diagram	
type	DatoNP_Type

element **Primo_Modulo_PL_Type/Prospetto/AltriDati/ResiduoCreditoSocialBonus**

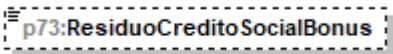
diagram	
type	DatoNP_Type

element **Primo_Modulo_PL_Type/Prospetto/AltriDati/ResiduoCreditoAttivitaFisica**

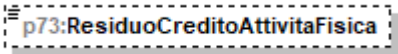
diagram	
type	DatoNP_Type

element **Primo_Modulo_PL_Type/Prospetto/AltriDati/ResiduoCreditoEnergia**

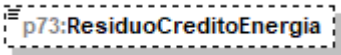
diagram	
type	DatoNP_Type

element **Primo_Modulo_PL_Type/Prospetto/AltriDati/ResiduoCreditoITS**

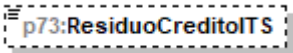
diagram	
type	DatoNP_Type

element **Primo_Modulo_PL_Type/Prospetto/AltriDati/ResiduoCreditoITSAItaDis**

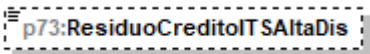
diagram	
type	DatoNP_Type

element **Primo_Modulo_PL_Type/Prospetto/AltriDati/ResiduoCreditoMediazioni**

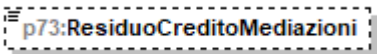
diagram	
type	DatoNP_Type

element **Primo_Modulo_PL_Type/Prospetto/AltriDati/RataSocialBonus**

diagram	
type	DatoNP_Type

element **Primo_Modulo_PL_Type/Prospetto/AltriDati/RataBonificaAmbientale**

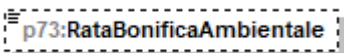
diagram	
type	DatoNP_Type

element **Primo_Modulo_PL_Type/Prospetto/AltriDati/CreditoErogazioneCultura**

<p>diagram</p>	
<p>type</p>	<p>p73:Cred Erogazione Cultura Type</p>
<p>children</p>	<p>p73:RataAnnoPrec p73:RataAnno</p>

element **Primo_Modulo_PL_Type/Prospetto/CredImpEestero**

<p>diagram</p>	
<p>type</p>	<p>p73:Cred Imp Estero Type</p>
<p>children</p>	<p>p73:Anno p73:TotCredito p73:CreditoStato</p>

element **Primo Modulo_PL_Type/Prospetto/DatiCreditiF24**

<p>diagram</p>	
<p>type</p>	<p>p73:Crediti_F24_Type</p>
<p>children</p>	<p>p73:Credlrpef p73:CredlrpefDipNoSostituto p73:CodAddReg p73:CredAddReg p73:CredAddRegDipNoSostituto p73:CodiceAddCom p73:CredAddCom p73:CredAddComDipNoSostituto p73:CredCedolare p73:CredCedolareDipNoSostituto p73:CredTassSeparDipNoSostituto p73:CredImpostaSostDipNoSostituto p73:Totale p73:TotaleDipNoSostituto</p>

element **Primo Modulo_PL_Type/ProspettoRideterminato**

<p>diagram</p>	
<p>type</p>	<p>extension of p73:Prospetto_Type</p>
<p>children</p>	<p>p73:RiepilogoRedditi p73:ImpostaLorda p73:DetrazioniCrediti p73:ImpostaNetta p73:RedditoAgevolazioniFiscali</p>

element **Primo Modulo_PL_Type/ProspettoRideterminato/RedditoAgevolazioniFiscali**

<p>diagram</p>	
<p>type</p>	<p>DatoNP_Type</p>

complexType **Prospetto_Liquidazione_Type**

<p>diagram</p>	
<p>children</p>	<p>p73:PrimoModulo p73:Modulo</p>

element **Prospetto_Liquidazione_Type/PrimoModulo**

<p>diagram</p>	
<p>type</p>	<p>p73:Primo Modulo_PL_Type</p>
<p>children</p>	<p>p73:Prospetto p73:ProspettoRideterminato</p>

element **Prospetto_Liquidazione_Type/Modulo**

diagram	<p>The diagram shows a dashed box labeled 'p73:Modulo' with a multiplicity of '0..∞' connected to a solid box labeled 'p73:Modulo_PL_Type'. Inside 'p73:Modulo_PL_Type' is a dashed box labeled 'p73:CredImpEstero' with a '+' sign.</p>
type	p73:Modulo_PL_Type
children	p73:CredImpEstero

complexType **Prospetto_Type**

diagram	<p>The diagram shows a solid box labeled 'Prospetto_Type' connected to a container box. Inside the container are four dashed boxes: 'p73:RiepilogoRedditi', 'p73:ImpostaLorda', 'p73:DetrazioniCrediti', and 'p73:ImpostaNetta', each with a '+' sign.</p>
children	p73:RiepilogoRedditi p73:ImpostaLorda p73:DetrazioniCrediti p73:ImpostaNetta

element **Prospetto_Type/RiepilogoRedditi**

diagram	<p>The diagram shows a dashed box labeled 'p73:RiepilogoRedditi' connected to a container box labeled 'p73:Riepilogo_Redditi_Type'. Inside this container are several dashed boxes representing sub-elements: 'p73:Dominicali', 'p73:Agrari', 'p73:Fabbricati', 'p73:LavDip', 'p73:AltriRedditi', 'p73:ImponibileCedolare', 'p73:ImponibileCedolareOrdinario', 'p73:ImponibileCedolareAgevolato', and 'p73:AbitazionePrincipalePertine...'.</p>
type	p73:Riepilogo_Redditi_Type
children	p73:Dominicali p73:Agrari p73:Fabbricati p73:LavDip p73:AltriRedditi p73:ImponibileCedolare p73:ImponibileCedolareOrdinario p73:ImponibileCedolareAgevolato p73:AbitazionePrincipalePertinenze

element **Prospetto_Type/ImpostaLorda**

<p>diagram</p>	
<p>type</p>	<p>p73:Imposta_Lorda_Type</p>
<p>children</p>	<p>p73:RedditoComplessivo p73:DeduzioneAbitazPrincipale p73:OneriDeducibili p73:RedditoImponibile p73:CompensiAttSport p73:ImportoImpostaLorda</p>

element **Prospetto_Type/DetrazioniCrediti**

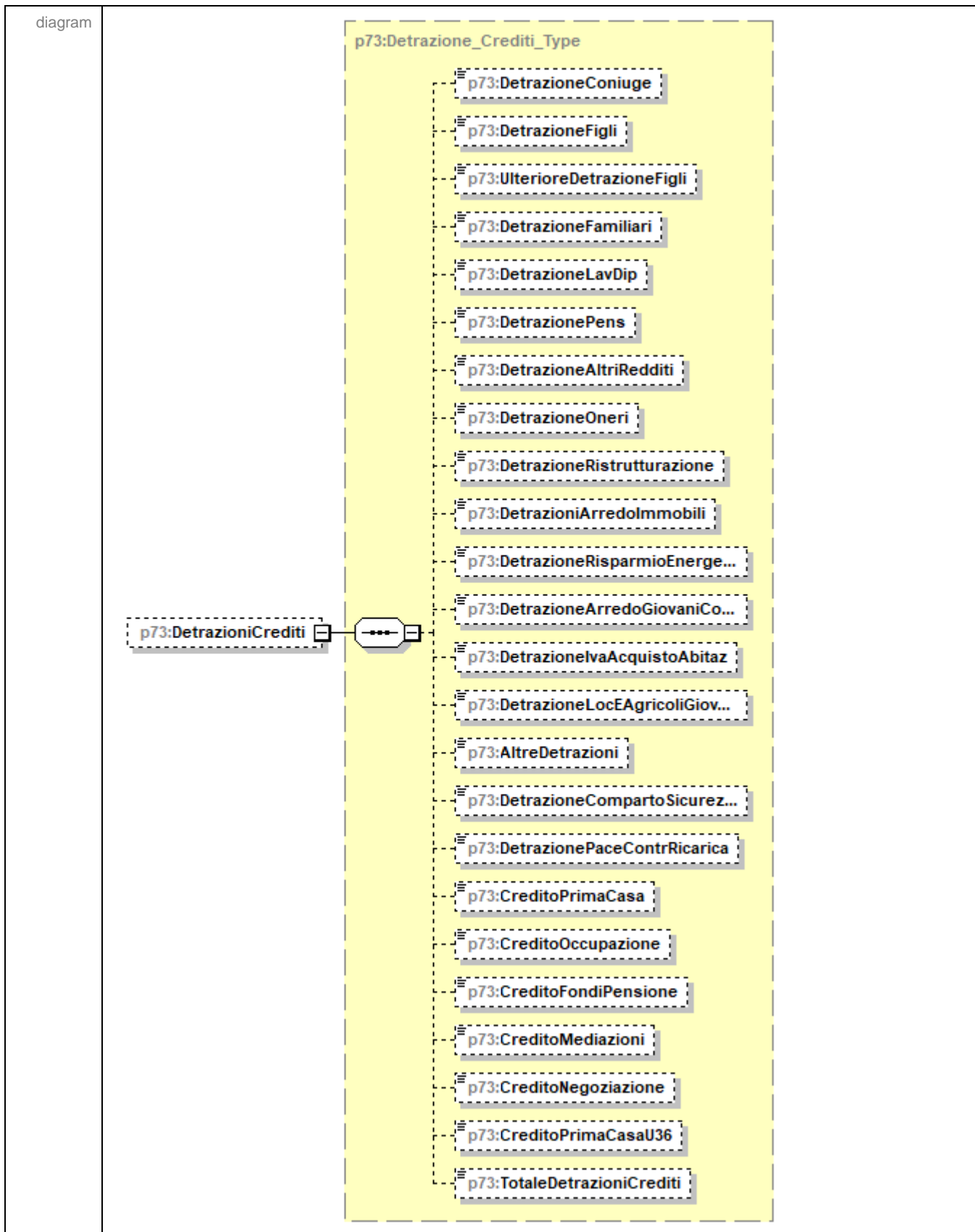

type	p73:Detrazione_Crediti_Type
children	p73:DetrazioneConiuge p73:DetrazioneFigli p73:UlterioreDetrazioneFigli p73:DetrazioneFamiliari p73:DetrazioneLavDip p73:DetrazionePens p73:DetrazioneAltriRedditi p73:DetrazioneOneri p73:DetrazioneRistrutturazione p73:DetrazioniArredolmmobili p73:DetrazioneRisparmioEnergetico p73:DetrazioneArredoGiovaniCoppie p73:DetrazioneIvaAcquistoAbitaz p73:DetrazioneLocEAgricoliGiovani p73:AltreDetrazioni p73:DetrazioneCompartoSicurezza p73:DetrazionePaceContrRicarica p73:CreditoPrimaCasa p73:CreditoOccupazione p73:CreditoFondiPensione p73:CreditoMediazioni p73:CreditoNegoziazione p73:CreditoPrimaCasaU36 p73:TotaleDetrazioniCrediti

element **Prospetto_Type/ImpostaNetta**

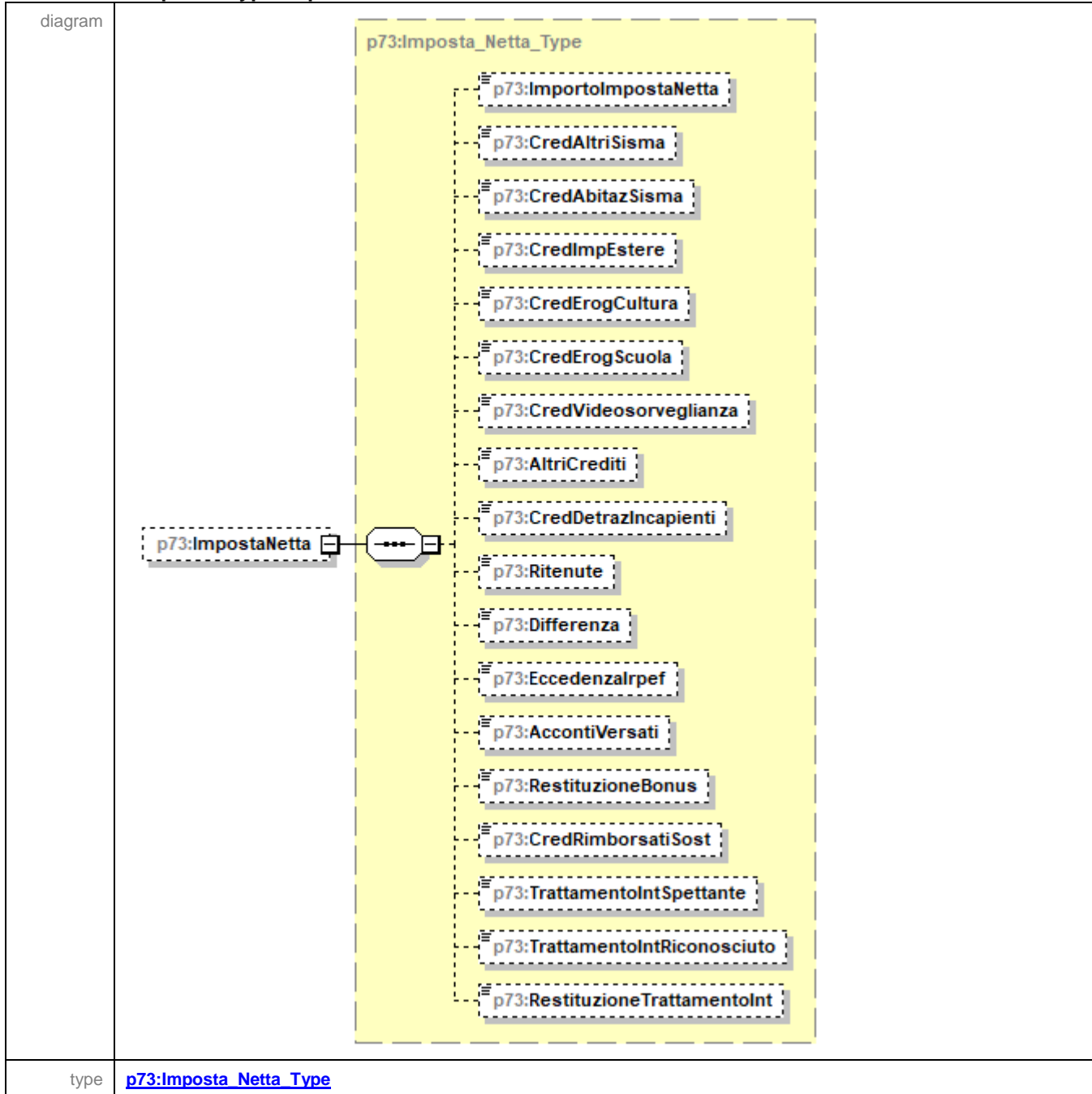

children	p73:ImportoImpostaNetta p73:CredAltriSisma p73:CredAbitazSisma p73:CredImpEstere p73:CredErogCultura p73:CredErogScuola p73:CredVideosorveglianza p73:AltriCrediti p73:CredDetrazIncapienti p73:Ritenute p73:Differenza p73:EccedenzaIrp p73:AccontiVersati p73:RestituzioneBonus p73:CredRimborsatiSost p73:TrattamentoIntSpettante p73:TrattamentoIntRiconosciuto p73:RestituzioneTrattamentoInt
----------	--

complexType **Redditi_Capitale_Type**

diagram	
children	p73:Utili p73:AltriRedditiDiCapitale p73:LavoroAutonomo p73:RedditiDiversi p73:RedditiDiversiDetraz

element **Redditi_Capitale_Type/Utili**

diagram	
type	p73:Altri Redditi Utili Type
children	p73:Tipo Reddito p73:RedditiRitenute

element **Redditi_Capitale_Type/AltriRedditiDiCapitale**

diagram	
type	p73:Sezione Altri Redd Type
children	p73:TipoReddito p73:RedditiRitenute

element **Redditi_Capitale_Type/LavoroAutonomo**

diagram	
type	p73:Altri_Redditi_Lavoro_Autonomo_Type
children	p73:AltriDati p73:TipoReddito p73:RedditiRitenute

element **Redditi_Capitale_Type/RedditiDiversi**

diagram	
type	p73:Altri_Redditi_Diversi_Type
children	p73:CedolareSecca p73:TipoReddito p73:RedditiRitenuteSpese

element **Redditi_Capitale_Type/RedditiDiversiDetraz**

diagram	
type	p73:Altri_Redditi_Diversi_Detr_Type
children	p73:AltriDati p73:Tipo_Reddito p73:RedditiRitenuteSpese

complexType **Redditi_Eredi_Legatari_Type**

<p>diagram</p>	
<p>type</p>	<p>extension of p73:Tassazione_Separata_Type</p>
<p>children</p>	<p>p73:Opzione p73:Anno p73:RedditoRitenute p73:TipoReddito p73:RedditoTotale p73:QuotalImposteSuccessioni</p>

element **Redditi_Eredi_Legatari_Type/TipoReddito**

<p>diagram</p>																																	
<p>type</p>	<p>restriction of DatoNP_Type</p>																																
<p>facets</p>	<table border="1"> <thead> <tr> <th>Kind</th> <th>Value</th> </tr> </thead> <tbody> <tr><td>enumeration</td><td>1</td></tr> <tr><td>enumeration</td><td>2</td></tr> <tr><td>enumeration</td><td>3</td></tr> <tr><td>enumeration</td><td>4</td></tr> <tr><td>enumeration</td><td>5</td></tr> <tr><td>enumeration</td><td>6</td></tr> <tr><td>enumeration</td><td>7</td></tr> <tr><td>enumeration</td><td>8</td></tr> <tr><td>enumeration</td><td>9</td></tr> <tr><td>enumeration</td><td>10</td></tr> <tr><td>enumeration</td><td>11</td></tr> <tr><td>enumeration</td><td>12</td></tr> <tr><td>enumeration</td><td>13</td></tr> <tr><td>enumeration</td><td>14</td></tr> <tr><td>enumeration</td><td>15</td></tr> </tbody> </table>	Kind	Value	enumeration	1	enumeration	2	enumeration	3	enumeration	4	enumeration	5	enumeration	6	enumeration	7	enumeration	8	enumeration	9	enumeration	10	enumeration	11	enumeration	12	enumeration	13	enumeration	14	enumeration	15
Kind	Value																																
enumeration	1																																
enumeration	2																																
enumeration	3																																
enumeration	4																																
enumeration	5																																
enumeration	6																																
enumeration	7																																
enumeration	8																																
enumeration	9																																
enumeration	10																																
enumeration	11																																
enumeration	12																																
enumeration	13																																
enumeration	14																																
enumeration	15																																

element **Redditi_Eredi_Legatari_Type/RedditoTotale**

<p>diagram</p>	
<p>type</p>	<p>DatoNP_Type</p>

element **Redditi Eredi Legatari Type/QuotaImposteSuccessioni**

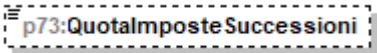
diagram	
type	DatoNP_Type

complexType **Redditi_Fabbricati_Type**

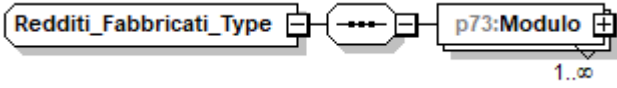
diagram	
children	p73:Modulo

element **Redditi_Fabbricati_Type/Modulo**

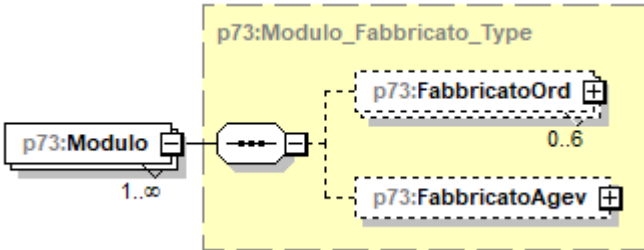
diagram	
type	p73:Modulo_Fabbricato_Type
children	p73:FabbricatoOrd p73:FabbricatoAgev

complexType **Redditi_Lavoro_Dip_Type**

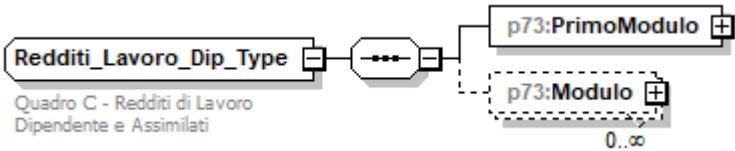
diagram	
children	p73:PrimoModulo p73:Modulo

element **Redditi Lavoro Dip_Type/PrimoModulo**

<p>diagram</p>	
<p>type</p>	<p>p73:Primo Modulo Lavoro Dip Type</p>
<p>children</p>	<p>p73:LavoroDipendente p73:PremiRisultato p73:PeriodoLavoro p73:AltriRedditiAssLavDip p73:RitenuteLavoroDipendente p73:RiduzionePressioneFiscale p73:CasellaCasiParticolari p73:StatoEstero p73:CompartoSicurezza</p>

element **Redditi Lavoro Dip_Type/Modulo**

<p>diagram</p>	
<p>type</p>	<p>p73:Modulo Lavoro Dip Type</p>
<p>children</p>	<p>p73:LavoroDipendente p73:PremiRisultato p73:AltriRedditiAssLavDip</p>

complexType Redditi_Ritenute_Spese_Type

diagram	
type	extension of p73:Redditi_Ritenute_Type
children	p73:ImportoRedditi p73:ImportoRitenute p73:ImportoSpese

element Redditi_Ritenute_Spese_Type/ImportoSpese

diagram	
type	DatoNP_Type

complexType Redditi_Ritenute_Type

diagram	
children	p73:ImportoRedditi p73:ImportoRitenute

element Redditi_Ritenute_Type/ImportoRedditi

diagram	
type	DatoNP_Type

element Redditi_Ritenute_Type/ImportoRitenute

diagram	
type	DatoNP_Type

complexType **Redditi_Tassazione_Separata_Type**

diagram	
children	p73:RedditiErede p73:ImposteRimborsate

element **Redditi_Tassazione_Separata_Type/RedditiErede**

diagram	
type	p73:Redditi Eredi Legatari Type
children	p73:Opzione p73:Anno p73:RedditoRitenute p73:TipoReddito p73:RedditoTotale p73:QuotaImposteSuccessioni

element **Redditi_Tassazione_Separata_Type/ImposteRimborsate**

diagram	
type	p73:Imposte Rimborsate Type
children	p73:TipoReddito p73:TassazioneSeparata

complexType **Redditi_Terreni_Type**

diagram	
children	p73:Modulo

element **Redditi_Terreni_Type/Modulo**

diagram	
type	p73:Modulo_Terreno_Type
children	p73:Terreno

complexType **Reddito_Campione_Franchi_Type**

diagram	
children	p73:Codice p73:Importo

element **Reddito_Campione_Franchi_Type/Codice**

diagram													
type	restriction of DatoNP_Type												
facets	<table border="1"> <thead> <tr> <th>Kind</th> <th>Value</th> </tr> </thead> <tbody> <tr> <td>enumeration</td> <td>1</td> </tr> <tr> <td>enumeration</td> <td>2</td> </tr> <tr> <td>enumeration</td> <td>3</td> </tr> <tr> <td>enumeration</td> <td>4</td> </tr> <tr> <td>enumeration</td> <td>5</td> </tr> </tbody> </table>	Kind	Value	enumeration	1	enumeration	2	enumeration	3	enumeration	4	enumeration	5
Kind	Value												
enumeration	1												
enumeration	2												
enumeration	3												
enumeration	4												
enumeration	5												

element **Reddito_Campione_Franchi_Type/Importo**

diagram	
type	DatoNP_Type

complexType **Reddito_Campione_Type**

diagram	
children	p73:Codice p73:Importo

element **Reddito_Campione_Type/Codice**

diagram											
type	restriction of DatoNP_Type										
facets	<table border="1"> <thead> <tr> <th>Kind</th> <th>Value</th> </tr> </thead> <tbody> <tr> <td>enumeration</td> <td>1</td> </tr> <tr> <td>enumeration</td> <td>2</td> </tr> <tr> <td>enumeration</td> <td>3</td> </tr> <tr> <td>enumeration</td> <td>6</td> </tr> </tbody> </table>	Kind	Value	enumeration	1	enumeration	2	enumeration	3	enumeration	6
Kind	Value										
enumeration	1										
enumeration	2										
enumeration	3										
enumeration	6										

element **Reddito_Campione_Type/Importo**

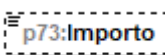
diagram	
type	DatoNP_Type

complexType **Reddito_Erede_Type**

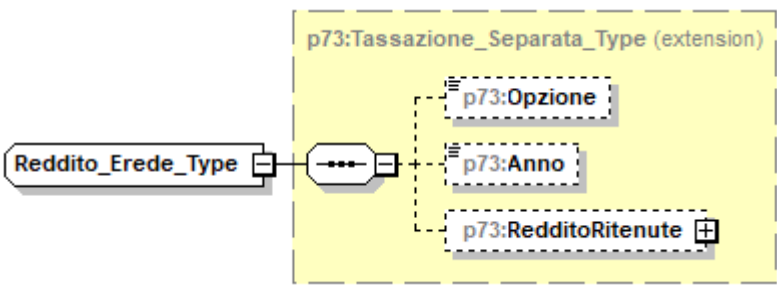
diagram	
type	extension of p73:Tassazione Separata_Type
children	p73:Opzione p73:Anno p73:RedditoRitenute

complexType **Residuo_Credito_Compens_AnnImposta_Type**

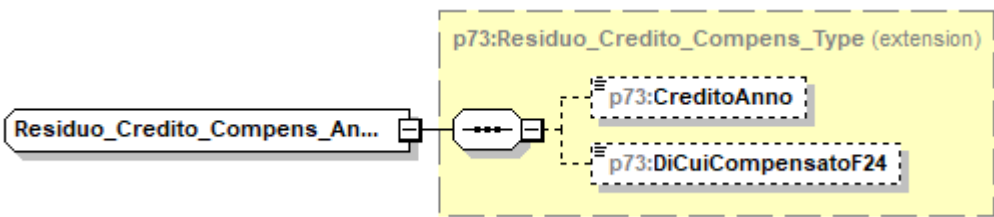
diagram	
type	extension of p73:Residuo_Credito_Compens_Type
children	p73:CreditoAnno p73:DiCuiCompensatoF24

complexType **Residuo_Credito_Compens_Type**

diagram	
children	p73:CreditoAnno p73:DiCuiCompensatoF24

element **Residuo_Credito_Compens_Type/CreditoAnno**

diagram	
type	DatoNP_Type

element **Residuo_Credito_Compens_Type/DiCuiCompensatoF24**

diagram	
type	DatoNP_Type

complexType **Residuo_Fabbricati_Type**

diagram	
children	p73:ResiduoPrecedenteDichiarazione p73:CreditoAnno p73:DiCuiCompensatoF24

element **Residuo_Fabbricati_Type/ResiduoPrecedenteDichiarazione**

diagram	
type	DatoNP_Type

element **Residuo_Fabbricati_Type/CreditoAnno**

diagram	
type	DatoNP_Type

element **Residuo_Fabbricati_Type/DiCuiCompensatoF24**

diagram	
type	DatoNP_Type

complexType **Residuo_Onlus_Type**

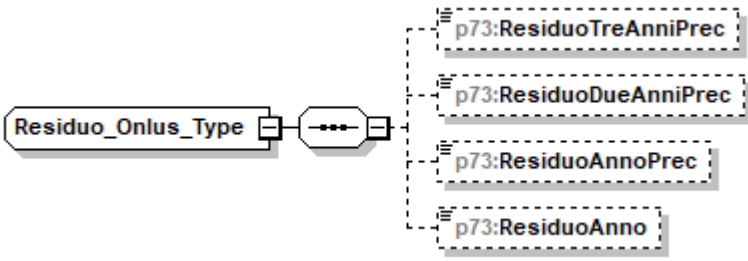
diagram	
children	p73:ResiduoTreAnniPrec p73:ResiduoDueAnniPrec p73:ResiduoAnnoPrec p73:ResiduoAnno

element **Residuo_Onlus_Type/ResiduoTreAnniPrec**

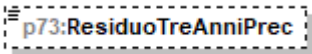
diagram	
type	DatoNP_Type

element **Residuo_Onlus_Type/ResiduoDueAnniPrec**

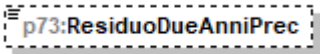
diagram	
type	DatoNP_Type

element **Residuo_Onlus_Type/ResiduoAnnoPrec**

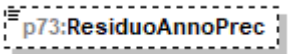
diagram	
type	DatoNP_Type

element **Residuo_Onlus_Type/ResiduoAnno**

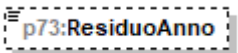
diagram	
type	DatoNP_Type

complexType Restituzione_Somme_Type

diagram	
children	p73:SommeRestituite p73:ResiduoPrecedenteDic

element Restituzione_Somme_Type/SommeRestituite

diagram	
type	DatoNP_Type

element Restituzione_Somme_Type/ResiduoPrecedenteDic

diagram	
type	DatoNP_Type

complexType Riduzione_Pressione_Type

diagram	
children	p73:CodiceTrattamento p73:TrattamentoErogato p73:EsenzioneRicercatori p73:EsenzioneImpatriati

element Riduzione_Pressione_Type/CodiceTrattamento

diagram							
type	restriction of DatoN1_Type						
facets	<table border="1"> <thead> <tr> <th>Kind</th> <th>Value</th> </tr> </thead> <tbody> <tr> <td>enumeration</td> <td>1</td> </tr> <tr> <td>enumeration</td> <td>2</td> </tr> </tbody> </table>	Kind	Value	enumeration	1	enumeration	2
Kind	Value						
enumeration	1						
enumeration	2						

element Riduzione_Pressione_Type/TrattamentoErogato

diagram	
---------	--

type	DatoNP_Type
------	-----------------------------

element **Riduzione_Pressione_Type/EsenzioneRicercatori**

diagram	
type	DatoNP_Type

element **Riduzione_Pressione_Type/EsenzioneImpatriati**

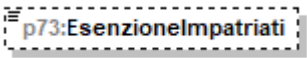
diagram	
type	DatoNP_Type

complexType **Riepilogo_Redditi_Type**

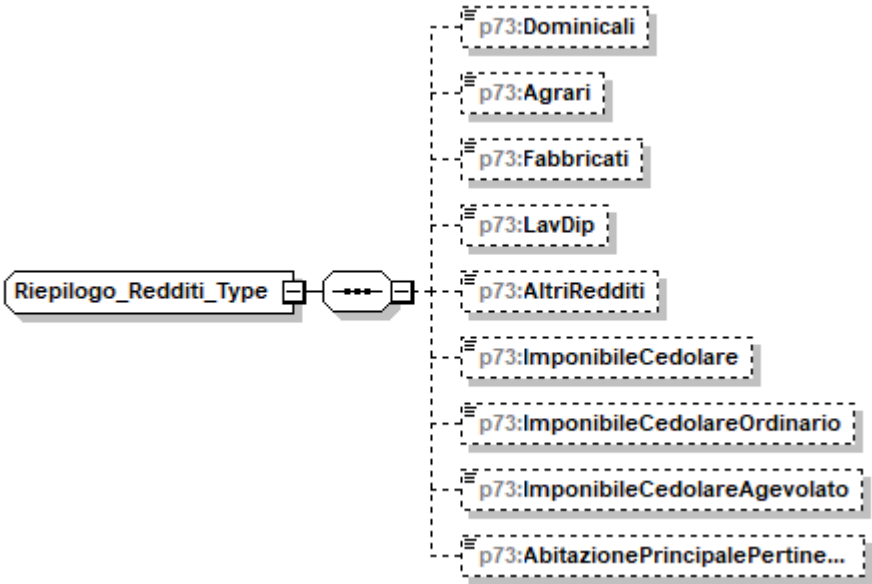
diagram	
children	p73:Dominicali p73:Agrari p73:Fabbricati p73:LavDip p73:AltriRedditi p73:ImponibileCedolare p73:ImponibileCedolareOrdinario p73:ImponibileCedolareAgevolato p73:AbitazionePrincipalePertinenze

element **Riepilogo_Redditi_Type/Dominicali**

diagram	
type	DatoNP_Type

element **Riepilogo_Reddi_Type/Agrari**

diagram	
type	DatoNP_Type

element **Riepilogo_Reddi_Type/Fabbricati**

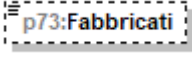
diagram	
type	DatoNP_Type

element **Riepilogo_Reddi_Type/LavDip**

diagram	
type	DatoNP_Type

element **Riepilogo_Reddi_Type/AltriRedditi**

diagram	
type	DatoNP_Type

element **Riepilogo_Reddi_Type/ImponibileCedolare**

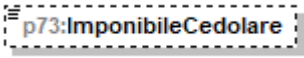
diagram	
type	DatoNP_Type

element **Riepilogo_Reddi_Type/ImponibileCedolareOrdinario**

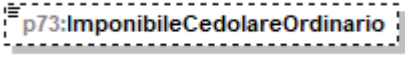
diagram	
type	DatoNP_Type

element **Riepilogo_Reddi_Type/ImponibileCedolareAgevolato**

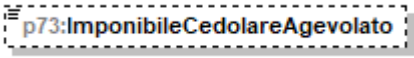
diagram	
type	DatoNP_Type

element **Riepilogo_Reddi_Type/AbitazionePrincipalePertinenze**

diagram	
type	DatoNP_Type

complexType **Ritenute_Acconti_Sospesi_Type**

diagram	
children	p73:CodiceEvento p73:lrpef p73:AddRegionalelrpef p73:AddComunalelrpef p73:SostitutivaPremi p73:CedolareSecca p73:SostitutivaRita

element **Ritenute_Acconti_Sospesi_Type/CodiceEvento**

diagram									
type	p73:Codice_Evento_Eccezionale_Type								
facets	<table border="1"> <thead> <tr> <th>Kind</th> <th>Value</th> </tr> </thead> <tbody> <tr> <td>enumeration</td> <td>1</td> </tr> <tr> <td>enumeration</td> <td>2</td> </tr> <tr> <td>enumeration</td> <td>99</td> </tr> </tbody> </table>	Kind	Value	enumeration	1	enumeration	2	enumeration	99
Kind	Value								
enumeration	1								
enumeration	2								
enumeration	99								

element **Ritenute_Acconti_Sospesi_Type/lrpef**

diagram	
type	DatoNP_Type

element **Ritenute_Acconti_Sospesi_Type/AddRegionalelrpef**

diagram	
type	DatoNP_Type

element **Ritenute_Acconti_Sospesi_Type/AddComunalelrpef**

diagram	
type	DatoNP_Type

element **Ritenute_Acconti_Sospesi_Type/SostitutivaPremi**

diagram	
type	DatoNP_Type

element **Ritenute_Acconti_Sospesi_Type/CedolareSecca**

diagram	
type	DatoNP_Type

element **Ritenute_Acconti_Sospesi_Type/SostitutivaRita**

diagram	
type	DatoNP_Type

complexType **Ritenute_Lavoro_Dip_Type**

diagram	
children	p73:Ritlrpef p73:RitRita p73:RitAddRegionale p73:RitAccAddComunale p73:RitSaldoAddComunale p73:RitAccAddComAnnoPres

element Ritenute_Lavoro_Dip_Type/Ritlrpef

diagram	
type	DatoNP_Type

element Ritenute_Lavoro_Dip_Type/RitRita

diagram	
type	DatoNP_Type

element Ritenute_Lavoro_Dip_Type/RitAddRegionale

diagram	
type	DatoNP_Type

element Ritenute_Lavoro_Dip_Type/RitAccAddComunale

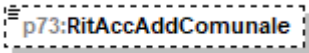
diagram	
type	DatoNP_Type

element Ritenute_Lavoro_Dip_Type/RitSaldoAddComunale

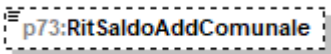
diagram	
type	DatoNP_Type

element Ritenute_Lavoro_Dip_Type/RitAccAddComAnnoPres

diagram	
type	DatoNP_Type

complexType Sezione_Altri_Redd_Type

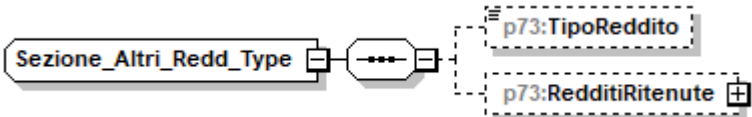
diagram	
children	p73:TipoReddito p73:RedditiRitenute

element **Sezione_Altri_Redd_Type/TipoReddito**

diagram																			
type	p73:Tipo Reddito Da1a8 Type																		
facets	<table border="1"> <thead> <tr> <th>Kind</th> <th>Value</th> </tr> </thead> <tbody> <tr><td>enumeration</td><td>1</td></tr> <tr><td>enumeration</td><td>2</td></tr> <tr><td>enumeration</td><td>3</td></tr> <tr><td>enumeration</td><td>4</td></tr> <tr><td>enumeration</td><td>5</td></tr> <tr><td>enumeration</td><td>6</td></tr> <tr><td>enumeration</td><td>7</td></tr> <tr><td>enumeration</td><td>8</td></tr> </tbody> </table>	Kind	Value	enumeration	1	enumeration	2	enumeration	3	enumeration	4	enumeration	5	enumeration	6	enumeration	7	enumeration	8
Kind	Value																		
enumeration	1																		
enumeration	2																		
enumeration	3																		
enumeration	4																		
enumeration	5																		
enumeration	6																		
enumeration	7																		
enumeration	8																		

element **Sezione_Altri_Redd_Type/RedditiRitenute**

diagram	
type	p73:Redditi Ritenute Type
children	p73:ImportoRedditi p73:ImportoRitenute

complexType **Sezione_Dati_Catastali_Recupero_Patrimonio_Edilizio_Type**

diagram	
children	p73:DatiCatastaliRecuperoPatrimonioEdilizio p73:DatiRegistrazioneAccatamentoRecuperoPatrimonio Edilizio

element **Sezione_Dati_Catastali_Recupero_Patrimonio_Edilizio_Type/DatiCatastaliRecuperoPatrimonioEdilizio**

diagram	
---------	--

type	extension of p73:Dati Catastali Recupero Patrimonio Edilizio Type
children	p73:NOrdImmobile p73:Condominio p73:DatiCatastali

element

Sezione Dati Catastali Recupero Patrimonio Edilizio Type/DatiRegistrazioneAccatastamentoRecuperoPatrimonio Edilizio

diagram	
type	p73:Dati Registrazione Accatastamento Recupero Patrimonio Edilizio Type
children	p73:NOrdImmobile p73:Condominio p73:EstremiRegistrazioneContratto p73:DomandaAccatastamento

complexType Soggetto Fiscale 730 Type

diagram	
children	p73:CodiceFiscale p73:Email p73:Telefono p73:Cellulare

element Soggetto Fiscale 730 Type/CodiceFiscale

diagram	
type	DatoCF Type

element Soggetto Fiscale 730 Type/Email

diagram	
type	DatoEM Type

element **Soggetto_Fiscale_730_Type/Telefono**

diagram	
type	DatoAN_Type

element **Soggetto_Fiscale_730_Type/Cellulare**

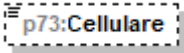
diagram	
type	DatoAN_Type

complexType **Soglie_Esenzione_Type**

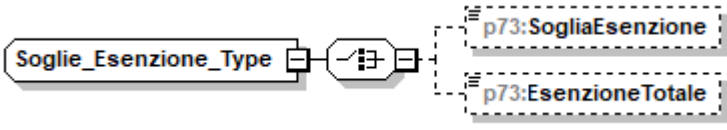
diagram	
children	p73:SogliaEsenzione p73:EsenzioneTotale

element **Soglie_Esenzione_Type/SogliaEsenzione**

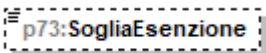
diagram	
type	DatoNP_Type

element **Soglie_Esenzione_Type/EsenzioneTotale**

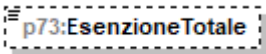
diagram							
type	restriction of DatoN1_Type						
facets	<table border="1"> <thead> <tr> <th>Kind</th> <th>Value</th> </tr> </thead> <tbody> <tr> <td>enumeration</td> <td>1</td> </tr> <tr> <td>enumeration</td> <td>2</td> </tr> </tbody> </table>	Kind	Value	enumeration	1	enumeration	2
Kind	Value						
enumeration	1						
enumeration	2						

complexType **Spese_Arredo_Giovani_Coppie_Type**

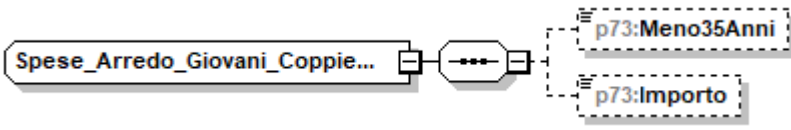
diagram	
children	p73:Meno35Anni p73:Importo

element **Spese_Arredo_Giovani_Coppie_Type/Meno35Anni**

diagram	
type	DatoCB_Type

element **Spese_Arredo_Giovani_Coppie_Type/Importo**

diagram	
type	DatoNP_Type

complexType **Spese_Arredo_Type**

diagram	
children	p73:NumeroRata p73:Importo

element **Spese_Arredo_Type/NumeroRata**

diagram																							
type	restriction of DatoNP_Type																						
facets	<table border="1"> <thead> <tr> <th>Kind</th> <th>Value</th> </tr> </thead> <tbody> <tr><td>enumeration</td><td>1</td></tr> <tr><td>enumeration</td><td>2</td></tr> <tr><td>enumeration</td><td>3</td></tr> <tr><td>enumeration</td><td>4</td></tr> <tr><td>enumeration</td><td>5</td></tr> <tr><td>enumeration</td><td>6</td></tr> <tr><td>enumeration</td><td>7</td></tr> <tr><td>enumeration</td><td>8</td></tr> <tr><td>enumeration</td><td>9</td></tr> <tr><td>enumeration</td><td>10</td></tr> </tbody> </table>	Kind	Value	enumeration	1	enumeration	2	enumeration	3	enumeration	4	enumeration	5	enumeration	6	enumeration	7	enumeration	8	enumeration	9	enumeration	10
Kind	Value																						
enumeration	1																						
enumeration	2																						
enumeration	3																						
enumeration	4																						
enumeration	5																						
enumeration	6																						
enumeration	7																						
enumeration	8																						
enumeration	9																						
enumeration	10																						

element **Spese_Arredo_Type/Importo**

diagram	
type	DatoNP_Type

complexType **Spese_Laurea_Ricarica_Type**

diagram	
children	p73:Codice p73:Anno p73:Importo

element **Spese_Laurea_Ricarica_Type/Codice**

diagram													
type	restriction of DatoNP_Type												
facets	<table border="1"> <thead> <tr> <th>Kind</th> <th>Value</th> </tr> </thead> <tbody> <tr> <td>enumeration</td> <td>1</td> </tr> <tr> <td>enumeration</td> <td>2</td> </tr> <tr> <td>enumeration</td> <td>3</td> </tr> <tr> <td>enumeration</td> <td>4</td> </tr> <tr> <td>enumeration</td> <td>5</td> </tr> </tbody> </table>	Kind	Value	enumeration	1	enumeration	2	enumeration	3	enumeration	4	enumeration	5
Kind	Value												
enumeration	1												
enumeration	2												
enumeration	3												
enumeration	4												
enumeration	5												

element **Spese_Laurea_Ricarica_Type/Anno**

diagram	
type	DatoDA_Type

element **Spese_Laurea_Ricarica_Type/Importo**

diagram	
type	DatoNP_Type

complexType **Spese_Leasing_Type**

diagram	
children	p73:DataStipula p73:NumeroAnno p73:Canone p73:PrezzoRiscatto

element **Spese_Leasing_Type/DataStipula**

diagram	
type	DatoDT_Type

element **Spese_Leasing_Type/NumeroAnno**

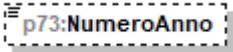
diagram													
type	restriction of DatoNP_Type												
facets	<table border="1"> <thead> <tr> <th>Kind</th> <th>Value</th> </tr> </thead> <tbody> <tr> <td>enumeration</td> <td>3</td> </tr> <tr> <td>enumeration</td> <td>4</td> </tr> <tr> <td>enumeration</td> <td>5</td> </tr> <tr> <td>enumeration</td> <td>6</td> </tr> <tr> <td>enumeration</td> <td>7</td> </tr> </tbody> </table>	Kind	Value	enumeration	3	enumeration	4	enumeration	5	enumeration	6	enumeration	7
Kind	Value												
enumeration	3												
enumeration	4												
enumeration	5												
enumeration	6												
enumeration	7												

element **Spese_Leasing_Type/Canone**

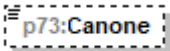
diagram	
type	restriction of DatoNP_Type

element **Spese_Leasing_Type/PrezzoRiscatto**

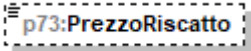
diagram	
type	restriction of DatoNP_Type

complexType **Spese_Rateizzate_Anni_Precedenti_Type**

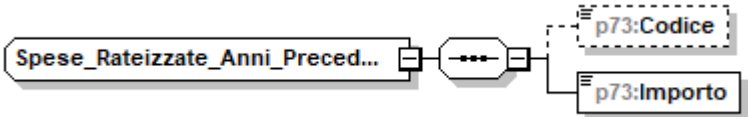
diagram	
children	p73:Codice p73:Importo

element **Spese_Rateizzate_Anni_Precedenti_Type/Codice**

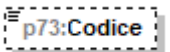
diagram									
type	p73:Codice Spese_Rateizzate_Anni_Precedenti_Type								
facets	<table border="1"> <thead> <tr> <th>Kind</th> <th>Value</th> </tr> </thead> <tbody> <tr> <td>enumeration</td> <td>2</td> </tr> <tr> <td>enumeration</td> <td>3</td> </tr> <tr> <td>enumeration</td> <td>4</td> </tr> </tbody> </table>	Kind	Value	enumeration	2	enumeration	3	enumeration	4
Kind	Value								
enumeration	2								
enumeration	3								
enumeration	4								

element **Spese_Rateizzate_Anni_Precedenti_Type/Importo**

diagram	
type	DatoNP_Type

complexType **Spese_Rateizzate_Type**

diagram	
children	p73:Codice p73:Importo

element **Spese_Rateizzate_Type/Codice**

diagram											
type	p73:Codice Spese_Rateizzate_Type										
facets	<table border="1"> <thead> <tr> <th>Kind</th> <th>Value</th> </tr> </thead> <tbody> <tr> <td>enumeration</td> <td>1</td> </tr> <tr> <td>enumeration</td> <td>2</td> </tr> <tr> <td>enumeration</td> <td>3</td> </tr> <tr> <td>enumeration</td> <td>4</td> </tr> </tbody> </table>	Kind	Value	enumeration	1	enumeration	2	enumeration	3	enumeration	4
Kind	Value										
enumeration	1										
enumeration	2										
enumeration	3										
enumeration	4										

element **Spese_Rateizzate_Type/Importo**

diagram	
type	DatoNP_Type

complexType **Tassazione_Separata_Type**

diagram	
children	p73:Opzione p73:Anno p73:RedditoRitenute

element **Tassazione_Separata_Type/Opzione**

diagram	
type	DatoCB_Type

element **Tassazione_Separata_Type/Anno**

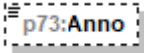
diagram	
type	DatoDA_Type

element **Tassazione_Separata_Type/RedditoRitenute**

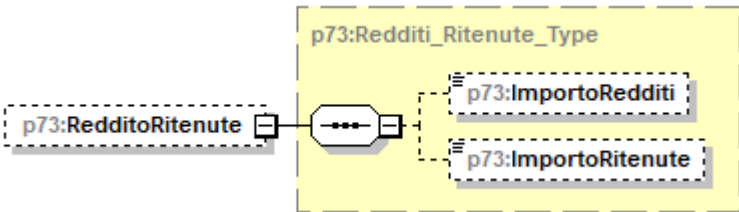
diagram	
type	p73:Redditi_Ritenute_Type
children	p73:ImportoRedditi p73:ImportoRitenute

complexType **Terreno_Type**

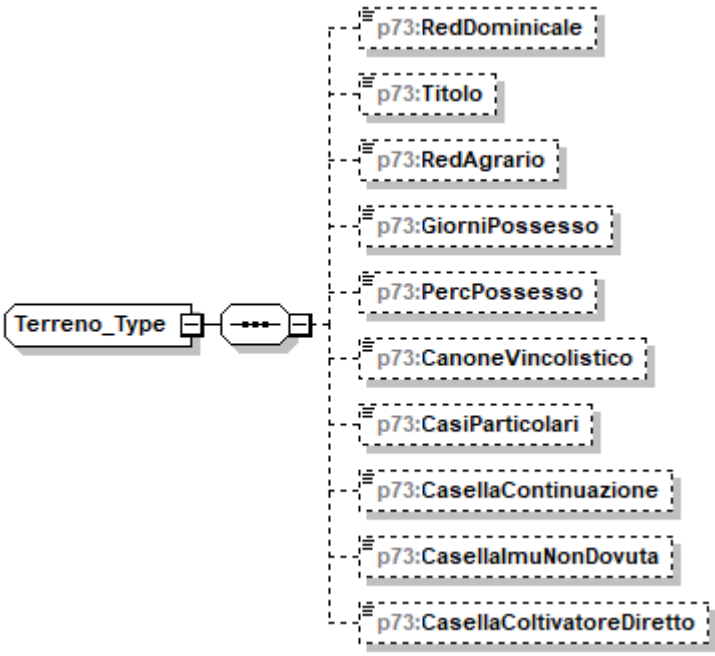
diagram	
children	p73:RedDominicale p73:Titolo p73:RedAgrario p73:GiorniPossesso p73:PercPossesso p73:CanoneVincolistico p73:CasiParticolari p73:CasellaContinuazione p73:CasellaImmuNonDovuta p73:CasellaColtivatoreDiretto

p73:CasiParticolari p73:CasellaContinuazione p73:CasellalmuNonDovuta p73:CasellaColtivatoreDiretto
--

element Terreno_Type/RedDominicale

diagram	
type	DatoNP_Type

element Terreno_Type/Titolo

diagram																			
type	p73:Titolo_Terreno_Type																		
facets	<table border="1"> <thead> <tr> <th>Kind</th> <th>Value</th> </tr> </thead> <tbody> <tr><td>enumeration</td><td>1</td></tr> <tr><td>enumeration</td><td>2</td></tr> <tr><td>enumeration</td><td>3</td></tr> <tr><td>enumeration</td><td>4</td></tr> <tr><td>enumeration</td><td>5</td></tr> <tr><td>enumeration</td><td>6</td></tr> <tr><td>enumeration</td><td>7</td></tr> <tr><td>enumeration</td><td>10</td></tr> </tbody> </table>	Kind	Value	enumeration	1	enumeration	2	enumeration	3	enumeration	4	enumeration	5	enumeration	6	enumeration	7	enumeration	10
Kind	Value																		
enumeration	1																		
enumeration	2																		
enumeration	3																		
enumeration	4																		
enumeration	5																		
enumeration	6																		
enumeration	7																		
enumeration	10																		

element Terreno_Type/RedAgrario

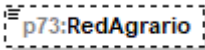
diagram	
type	DatoNP_Type

element Terreno_Type/GiorniPossesso

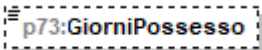
diagram	
type	DatoGA_Type

element Terreno_Type/PercPossesso

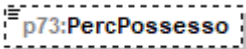
diagram	
type	DatoPC_Type

element Terreno_Type/CanoneVincolistico

diagram	
---------	---

type	DatoNP_Type
------	-----------------------------

element Terreno_Type/CasiParticolari

diagram											
type	p73:Casi Particolari Terreni_Type										
facets	<table border="1"> <thead> <tr> <th>Kind</th> <th>Value</th> </tr> </thead> <tbody> <tr> <td>enumeration</td> <td>2</td> </tr> <tr> <td>enumeration</td> <td>3</td> </tr> <tr> <td>enumeration</td> <td>4</td> </tr> <tr> <td>enumeration</td> <td>6</td> </tr> </tbody> </table>	Kind	Value	enumeration	2	enumeration	3	enumeration	4	enumeration	6
Kind	Value										
enumeration	2										
enumeration	3										
enumeration	4										
enumeration	6										

element Terreno_Type/CasellaContinuazione

diagram	
type	DatoCB_Type

element Terreno_Type/CasellaImmuNonDovuta

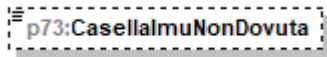
diagram	
type	DatoCB_Type

element Terreno_Type/CasellaColtivatoreDiretto

diagram	
type	DatoCB_Type

complexType Ulteriori_Dati_Type

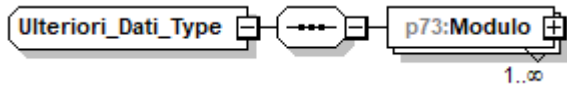
diagram	
children	p73:Modulo

element **Ulteriori_Dati_Type/Modulo**

diagram	<pre> classDiagram class p73Modulo { 1..∞ } class p73Modulo_Ulteriori_Dati_Type { p73RedditoCampione p73RedditoCampioneFranchi } p73Modulo "1..∞" -- "*" p73Modulo_Ulteriori_Dati_Type </pre>
type	p73:Modulo_Ulteriori_Dati_Type
children	p73:RedditoCampione p73:RedditoCampioneFranchi

simpleType **Anno_Anticipazione_Fondo_Pensione_Type**

type	restriction of DatoNP_Type																																		
facets	<table border="1"> <thead> <tr> <th>Kind</th> <th>Value</th> </tr> </thead> <tbody> <tr><td>enumeration</td><td>2007</td></tr> <tr><td>enumeration</td><td>2008</td></tr> <tr><td>enumeration</td><td>2009</td></tr> <tr><td>enumeration</td><td>2010</td></tr> <tr><td>enumeration</td><td>2011</td></tr> <tr><td>enumeration</td><td>2012</td></tr> <tr><td>enumeration</td><td>2013</td></tr> <tr><td>enumeration</td><td>2014</td></tr> <tr><td>enumeration</td><td>2015</td></tr> <tr><td>enumeration</td><td>2016</td></tr> <tr><td>enumeration</td><td>2017</td></tr> <tr><td>enumeration</td><td>2018</td></tr> <tr><td>enumeration</td><td>2019</td></tr> <tr><td>enumeration</td><td>2020</td></tr> <tr><td>enumeration</td><td>2021</td></tr> <tr><td>enumeration</td><td>2022</td></tr> </tbody> </table>	Kind	Value	enumeration	2007	enumeration	2008	enumeration	2009	enumeration	2010	enumeration	2011	enumeration	2012	enumeration	2013	enumeration	2014	enumeration	2015	enumeration	2016	enumeration	2017	enumeration	2018	enumeration	2019	enumeration	2020	enumeration	2021	enumeration	2022
Kind	Value																																		
enumeration	2007																																		
enumeration	2008																																		
enumeration	2009																																		
enumeration	2010																																		
enumeration	2011																																		
enumeration	2012																																		
enumeration	2013																																		
enumeration	2014																																		
enumeration	2015																																		
enumeration	2016																																		
enumeration	2017																																		
enumeration	2018																																		
enumeration	2019																																		
enumeration	2020																																		
enumeration	2021																																		
enumeration	2022																																		

simpleType **Anno_Patrimonio_Edilizio_Situazioni_Particolari_Type**

type	restriction of DatoNP_Type				
facets	<table border="1"> <thead> <tr> <th>Kind</th> <th>Value</th> </tr> </thead> <tbody> <tr><td>enumeration</td><td>2011</td></tr> </tbody> </table>	Kind	Value	enumeration	2011
Kind	Value				
enumeration	2011				

simpleType **Anno_Recupero_Patrimonio_Edilizio_Type**

type	restriction of DatoNP_Type																						
facets	<table border="1"> <thead> <tr> <th>Kind</th> <th>Value</th> </tr> </thead> <tbody> <tr><td>enumeration</td><td>2013</td></tr> <tr><td>enumeration</td><td>2014</td></tr> <tr><td>enumeration</td><td>2015</td></tr> <tr><td>enumeration</td><td>2016</td></tr> <tr><td>enumeration</td><td>2017</td></tr> <tr><td>enumeration</td><td>2018</td></tr> <tr><td>enumeration</td><td>2019</td></tr> <tr><td>enumeration</td><td>2020</td></tr> <tr><td>enumeration</td><td>2021</td></tr> <tr><td>enumeration</td><td>2022</td></tr> </tbody> </table>	Kind	Value	enumeration	2013	enumeration	2014	enumeration	2015	enumeration	2016	enumeration	2017	enumeration	2018	enumeration	2019	enumeration	2020	enumeration	2021	enumeration	2022
Kind	Value																						
enumeration	2013																						
enumeration	2014																						
enumeration	2015																						
enumeration	2016																						
enumeration	2017																						
enumeration	2018																						
enumeration	2019																						
enumeration	2020																						
enumeration	2021																						
enumeration	2022																						

simpleType Anno_Risparmio_Energetico_Type

type	restriction of DatoNP_Type	
facets	Kind	Value
	enumeration	2008
	enumeration	2013
	enumeration	2014
	enumeration	2015
	enumeration	2016
	enumeration	2017
	enumeration	2018
	enumeration	2019
	enumeration	2020
	enumeration	2021
	enumeration	2022

simpleType Casella_Codice_Type

type	restriction of DatoN1_Type	
facets	Kind	Value
	enumeration	4

simpleType Casi_Particolari_Fabbricato_Type

type	restriction of DatoN1_Type	
facets	Kind	Value
	enumeration	1
	enumeration	3
	enumeration	4
	enumeration	5
	enumeration	6
	enumeration	7
	enumeration	8

simpleType Casi_Particolari_Risp_Ener_Type

type	restriction of DatoN1_Type	
facets	Kind	Value
	enumeration	1
	enumeration	2
	enumeration	3

simpleType Casi_Particolari_Terreni_Type

type	restriction of DatoN1_Type	
facets	Kind	Value
	enumeration	2
	enumeration	3
	enumeration	4
	enumeration	6

simpleType Codice_Altre_Detrazioni_Type

type	restriction of DatoNP_Type	
facets	Kind	Value
	enumeration	1
	enumeration	2

	enumeration 3
	enumeration 4

simpleType Codice_Altre_Spese_Type

type	restriction of DatoNP_Type																																																																																		
facets	<table border="1"> <thead> <tr> <th>Kind</th> <th>Value</th> </tr> </thead> <tbody> <tr><td>enumeration</td><td>8</td></tr> <tr><td>enumeration</td><td>9</td></tr> <tr><td>enumeration</td><td>10</td></tr> <tr><td>enumeration</td><td>11</td></tr> <tr><td>enumeration</td><td>12</td></tr> <tr><td>enumeration</td><td>13</td></tr> <tr><td>enumeration</td><td>14</td></tr> <tr><td>enumeration</td><td>15</td></tr> <tr><td>enumeration</td><td>16</td></tr> <tr><td>enumeration</td><td>17</td></tr> <tr><td>enumeration</td><td>18</td></tr> <tr><td>enumeration</td><td>20</td></tr> <tr><td>enumeration</td><td>21</td></tr> <tr><td>enumeration</td><td>22</td></tr> <tr><td>enumeration</td><td>24</td></tr> <tr><td>enumeration</td><td>25</td></tr> <tr><td>enumeration</td><td>26</td></tr> <tr><td>enumeration</td><td>27</td></tr> <tr><td>enumeration</td><td>28</td></tr> <tr><td>enumeration</td><td>29</td></tr> <tr><td>enumeration</td><td>30</td></tr> <tr><td>enumeration</td><td>31</td></tr> <tr><td>enumeration</td><td>32</td></tr> <tr><td>enumeration</td><td>33</td></tr> <tr><td>enumeration</td><td>35</td></tr> <tr><td>enumeration</td><td>36</td></tr> <tr><td>enumeration</td><td>38</td></tr> <tr><td>enumeration</td><td>39</td></tr> <tr><td>enumeration</td><td>40</td></tr> <tr><td>enumeration</td><td>43</td></tr> <tr><td>enumeration</td><td>44</td></tr> <tr><td>enumeration</td><td>45</td></tr> <tr><td>enumeration</td><td>46</td></tr> <tr><td>enumeration</td><td>47</td></tr> <tr><td>enumeration</td><td>61</td></tr> <tr><td>enumeration</td><td>62</td></tr> <tr><td>enumeration</td><td>71</td></tr> <tr><td>enumeration</td><td>76</td></tr> <tr><td>enumeration</td><td>81</td></tr> <tr><td>enumeration</td><td>99</td></tr> </tbody> </table>	Kind	Value	enumeration	8	enumeration	9	enumeration	10	enumeration	11	enumeration	12	enumeration	13	enumeration	14	enumeration	15	enumeration	16	enumeration	17	enumeration	18	enumeration	20	enumeration	21	enumeration	22	enumeration	24	enumeration	25	enumeration	26	enumeration	27	enumeration	28	enumeration	29	enumeration	30	enumeration	31	enumeration	32	enumeration	33	enumeration	35	enumeration	36	enumeration	38	enumeration	39	enumeration	40	enumeration	43	enumeration	44	enumeration	45	enumeration	46	enumeration	47	enumeration	61	enumeration	62	enumeration	71	enumeration	76	enumeration	81	enumeration	99
Kind	Value																																																																																		
enumeration	8																																																																																		
enumeration	9																																																																																		
enumeration	10																																																																																		
enumeration	11																																																																																		
enumeration	12																																																																																		
enumeration	13																																																																																		
enumeration	14																																																																																		
enumeration	15																																																																																		
enumeration	16																																																																																		
enumeration	17																																																																																		
enumeration	18																																																																																		
enumeration	20																																																																																		
enumeration	21																																																																																		
enumeration	22																																																																																		
enumeration	24																																																																																		
enumeration	25																																																																																		
enumeration	26																																																																																		
enumeration	27																																																																																		
enumeration	28																																																																																		
enumeration	29																																																																																		
enumeration	30																																																																																		
enumeration	31																																																																																		
enumeration	32																																																																																		
enumeration	33																																																																																		
enumeration	35																																																																																		
enumeration	36																																																																																		
enumeration	38																																																																																		
enumeration	39																																																																																		
enumeration	40																																																																																		
enumeration	43																																																																																		
enumeration	44																																																																																		
enumeration	45																																																																																		
enumeration	46																																																																																		
enumeration	47																																																																																		
enumeration	61																																																																																		
enumeration	62																																																																																		
enumeration	71																																																																																		
enumeration	76																																																																																		
enumeration	81																																																																																		
enumeration	99																																																																																		

simpleType Codice_Altri_Oneri_Type

type	restriction of DatoNP_Type																
facets	<table border="1"> <thead> <tr> <th>Kind</th> <th>Value</th> </tr> </thead> <tbody> <tr><td>enumeration</td><td>6</td></tr> <tr><td>enumeration</td><td>7</td></tr> <tr><td>enumeration</td><td>8</td></tr> <tr><td>enumeration</td><td>9</td></tr> <tr><td>enumeration</td><td>12</td></tr> <tr><td>enumeration</td><td>13</td></tr> <tr><td>enumeration</td><td>21</td></tr> </tbody> </table>	Kind	Value	enumeration	6	enumeration	7	enumeration	8	enumeration	9	enumeration	12	enumeration	13	enumeration	21
Kind	Value																
enumeration	6																
enumeration	7																
enumeration	8																
enumeration	9																
enumeration	12																
enumeration	13																
enumeration	21																

simpleType **Codice_Canone_Type**

type	restriction of DatoN1_Type	
facets	Kind	Value
	enumeration	1
	enumeration	2
	enumeration	3
	enumeration	4

simpleType **Codice_Evento_Eccezionale_Type**

type	restriction of DatoNP_Type	
facets	Kind	Value
	enumeration	1
	enumeration	2
	enumeration	99

simpleType **Codice_Spese_Rateizzate_Anni_Precedenti_Type**

type	restriction of DatoNP_Type	
facets	Kind	Value
	enumeration	2
	enumeration	3
	enumeration	4

simpleType **Codice_Spese_Rateizzate_Type**

type	restriction of DatoNP_Type	
facets	Kind	Value
	enumeration	1
	enumeration	2
	enumeration	3
	enumeration	4

simpleType **Fabbricato_Agev_Numero_Rigo_Type**

type	restriction of DatoNP_Type	
facets	Kind	Value
	enumeration	1
	enumeration	2
	enumeration	3
	enumeration	4
	enumeration	5
	enumeration	6
	enumeration	7
	enumeration	8
	enumeration	9
	enumeration	10

simpleType **Indeterminato_Determinato_Type**

type	restriction of DatoN1_Type	
facets	Kind	Value
	enumeration	1
	enumeration	2

simpleType Mesi_Type

type	restriction of DatoNP_Type	
facets	Kind	Value
	enumeration	1
	enumeration	2
	enumeration	3
	enumeration	4
	enumeration	5
	enumeration	6
	enumeration	7
	enumeration	8
	enumeration	9
	enumeration	10
	enumeration	11
	enumeration	12

simpleType Numero_Rata_Risparmio_Energetico_Type

type	restriction of DatoNP_Type	
facets	Kind	Value
	enumeration	1
	enumeration	2
	enumeration	3
	enumeration	4
	enumeration	5
	enumeration	6
	enumeration	7
	enumeration	8
	enumeration	9
	enumeration	10

simpleType Numero_Rate5o10_Type

type	restriction of DatoNP_Type	
facets	Kind	Value
	enumeration	5
	enumeration	10

simpleType Periodo_Spese_Ristrutturazione_Type

type	restriction of DatoNP_Type	
facets	Kind	Value
	enumeration	2
	enumeration	3
	enumeration	4
	enumeration	5
	enumeration	6
	enumeration	7
	enumeration	8
	enumeration	9
	enumeration	10
	enumeration	11
	enumeration	12
	enumeration	13
	enumeration	15
	enumeration	16
	enumeration	17
	enumeration	18
	enumeration	19

	enumeration 20
	enumeration 21
	enumeration 22

simpleType Rate10_Type

type	restriction of DatoNP_Type																						
facets	<table border="1"> <thead> <tr> <th>Kind</th> <th>Value</th> </tr> </thead> <tbody> <tr><td>enumeration</td><td>1</td></tr> <tr><td>enumeration</td><td>2</td></tr> <tr><td>enumeration</td><td>3</td></tr> <tr><td>enumeration</td><td>4</td></tr> <tr><td>enumeration</td><td>5</td></tr> <tr><td>enumeration</td><td>6</td></tr> <tr><td>enumeration</td><td>7</td></tr> <tr><td>enumeration</td><td>8</td></tr> <tr><td>enumeration</td><td>9</td></tr> <tr><td>enumeration</td><td>10</td></tr> </tbody> </table>	Kind	Value	enumeration	1	enumeration	2	enumeration	3	enumeration	4	enumeration	5	enumeration	6	enumeration	7	enumeration	8	enumeration	9	enumeration	10
Kind	Value																						
enumeration	1																						
enumeration	2																						
enumeration	3																						
enumeration	4																						
enumeration	5																						
enumeration	6																						
enumeration	7																						
enumeration	8																						
enumeration	9																						
enumeration	10																						

simpleType Rate5_Type

type	restriction of DatoNP_Type				
facets	<table border="1"> <thead> <tr> <th>Kind</th> <th>Value</th> </tr> </thead> <tbody> <tr><td>enumeration</td><td>5</td></tr> </tbody> </table>	Kind	Value	enumeration	5
Kind	Value				
enumeration	5				

simpleType Rate_Risparmio_Energetico_Type

type	restriction of DatoNP_Type												
facets	<table border="1"> <thead> <tr> <th>Kind</th> <th>Value</th> </tr> </thead> <tbody> <tr><td>enumeration</td><td>6</td></tr> <tr><td>enumeration</td><td>7</td></tr> <tr><td>enumeration</td><td>8</td></tr> <tr><td>enumeration</td><td>9</td></tr> <tr><td>enumeration</td><td>10</td></tr> </tbody> </table>	Kind	Value	enumeration	6	enumeration	7	enumeration	8	enumeration	9	enumeration	10
Kind	Value												
enumeration	6												
enumeration	7												
enumeration	8												
enumeration	9												
enumeration	10												

simpleType Reintegro_Totale_Parziale_Type

type	restriction of DatoN1_Type						
facets	<table border="1"> <thead> <tr> <th>Kind</th> <th>Value</th> </tr> </thead> <tbody> <tr><td>enumeration</td><td>1</td></tr> <tr><td>enumeration</td><td>2</td></tr> </tbody> </table>	Kind	Value	enumeration	1	enumeration	2
Kind	Value						
enumeration	1						
enumeration	2						

simpleType Rideterminazione_Rate_Type

type	restriction of DatoNP_Type				
facets	<table border="1"> <thead> <tr> <th>Kind</th> <th>Value</th> </tr> </thead> <tbody> <tr><td>enumeration</td><td>10</td></tr> </tbody> </table>	Kind	Value	enumeration	10
Kind	Value				
enumeration	10				

simpleType Ripart_Risparmio_Energetico_Type

type	restriction of DatoNP_Type						
facets	<table border="1"> <thead> <tr> <th>Kind</th> <th>Value</th> </tr> </thead> <tbody> <tr><td>enumeration</td><td>9</td></tr> <tr><td>enumeration</td><td>10</td></tr> </tbody> </table>	Kind	Value	enumeration	9	enumeration	10
Kind	Value						
enumeration	9						
enumeration	10						

simpleType Serie_Registrazione_Contratto_Type

type	restriction of DatoAN_Type														
facets	<table border="1"> <thead> <tr> <th>Kind</th> <th>Value</th> </tr> </thead> <tbody> <tr> <td>enumeration</td> <td>3</td> </tr> <tr> <td>enumeration</td> <td>3A</td> </tr> <tr> <td>enumeration</td> <td>3B</td> </tr> <tr> <td>enumeration</td> <td>3P</td> </tr> <tr> <td>enumeration</td> <td>1T</td> </tr> <tr> <td>enumeration</td> <td>3T</td> </tr> </tbody> </table>	Kind	Value	enumeration	3	enumeration	3A	enumeration	3B	enumeration	3P	enumeration	1T	enumeration	3T
Kind	Value														
enumeration	3														
enumeration	3A														
enumeration	3B														
enumeration	3P														
enumeration	1T														
enumeration	3T														

simpleType Terreni_Urbano_Type

type	restriction of DatoAN_Type						
facets	<table border="1"> <thead> <tr> <th>Kind</th> <th>Value</th> </tr> </thead> <tbody> <tr> <td>enumeration</td> <td>T</td> </tr> <tr> <td>enumeration</td> <td>U</td> </tr> </tbody> </table>	Kind	Value	enumeration	T	enumeration	U
Kind	Value						
enumeration	T						
enumeration	U						

simpleType Tipo_Inquilino_Type

type	restriction of DatoNP_Type								
facets	<table border="1"> <thead> <tr> <th>Kind</th> <th>Value</th> </tr> </thead> <tbody> <tr> <td>enumeration</td> <td>1</td> </tr> <tr> <td>enumeration</td> <td>2</td> </tr> <tr> <td>enumeration</td> <td>4</td> </tr> </tbody> </table>	Kind	Value	enumeration	1	enumeration	2	enumeration	4
Kind	Value								
enumeration	1								
enumeration	2								
enumeration	4								

simpleType Tipo_Intervento_Type

type	restriction of DatoNP_Type																																										
facets	<table border="1"> <thead> <tr> <th>Kind</th> <th>Value</th> </tr> </thead> <tbody> <tr><td>enumeration</td><td>1</td></tr> <tr><td>enumeration</td><td>2</td></tr> <tr><td>enumeration</td><td>3</td></tr> <tr><td>enumeration</td><td>4</td></tr> <tr><td>enumeration</td><td>5</td></tr> <tr><td>enumeration</td><td>6</td></tr> <tr><td>enumeration</td><td>7</td></tr> <tr><td>enumeration</td><td>8</td></tr> <tr><td>enumeration</td><td>9</td></tr> <tr><td>enumeration</td><td>10</td></tr> <tr><td>enumeration</td><td>11</td></tr> <tr><td>enumeration</td><td>12</td></tr> <tr><td>enumeration</td><td>13</td></tr> <tr><td>enumeration</td><td>14</td></tr> <tr><td>enumeration</td><td>15</td></tr> <tr><td>enumeration</td><td>16</td></tr> <tr><td>enumeration</td><td>30</td></tr> <tr><td>enumeration</td><td>31</td></tr> <tr><td>enumeration</td><td>32</td></tr> <tr><td>enumeration</td><td>33</td></tr> </tbody> </table>	Kind	Value	enumeration	1	enumeration	2	enumeration	3	enumeration	4	enumeration	5	enumeration	6	enumeration	7	enumeration	8	enumeration	9	enumeration	10	enumeration	11	enumeration	12	enumeration	13	enumeration	14	enumeration	15	enumeration	16	enumeration	30	enumeration	31	enumeration	32	enumeration	33
Kind	Value																																										
enumeration	1																																										
enumeration	2																																										
enumeration	3																																										
enumeration	4																																										
enumeration	5																																										
enumeration	6																																										
enumeration	7																																										
enumeration	8																																										
enumeration	9																																										
enumeration	10																																										
enumeration	11																																										
enumeration	12																																										
enumeration	13																																										
enumeration	14																																										
enumeration	15																																										
enumeration	16																																										
enumeration	30																																										
enumeration	31																																										
enumeration	32																																										
enumeration	33																																										

simpleType Tipo_Reddito_Da1a12_Type

type	restriction of DatoNP_Type								
facets	<table border="1"> <thead> <tr> <th>Kind</th> <th>Value</th> </tr> </thead> <tbody> <tr> <td>enumeration</td> <td>1</td> </tr> <tr> <td>enumeration</td> <td>2</td> </tr> <tr> <td>enumeration</td> <td>3</td> </tr> </tbody> </table>	Kind	Value	enumeration	1	enumeration	2	enumeration	3
Kind	Value								
enumeration	1								
enumeration	2								
enumeration	3								

	enumeration 4
	enumeration 5
	enumeration 6
	enumeration 7
	enumeration 8
	enumeration 9
	enumeration 10
	enumeration 11
	enumeration 12

simpleType Tipo_Redito_Da1a3_Type

type	restriction of DatoN1_Type								
facets	<table border="1"> <thead> <tr> <th>Kind</th> <th>Value</th> </tr> </thead> <tbody> <tr> <td>enumeration</td> <td>1</td> </tr> <tr> <td>enumeration</td> <td>2</td> </tr> <tr> <td>enumeration</td> <td>3</td> </tr> </tbody> </table>	Kind	Value	enumeration	1	enumeration	2	enumeration	3
Kind	Value								
enumeration	1								
enumeration	2								
enumeration	3								

simpleType Tipo_Redito_Da1a4_Type

type	restriction of DatoN1_Type										
facets	<table border="1"> <thead> <tr> <th>Kind</th> <th>Value</th> </tr> </thead> <tbody> <tr> <td>enumeration</td> <td>1</td> </tr> <tr> <td>enumeration</td> <td>2</td> </tr> <tr> <td>enumeration</td> <td>3</td> </tr> <tr> <td>enumeration</td> <td>4</td> </tr> </tbody> </table>	Kind	Value	enumeration	1	enumeration	2	enumeration	3	enumeration	4
Kind	Value										
enumeration	1										
enumeration	2										
enumeration	3										
enumeration	4										

simpleType Tipo_Redito_Da1a6_Type

type	restriction of DatoN1_Type														
facets	<table border="1"> <thead> <tr> <th>Kind</th> <th>Value</th> </tr> </thead> <tbody> <tr> <td>enumeration</td> <td>1</td> </tr> <tr> <td>enumeration</td> <td>2</td> </tr> <tr> <td>enumeration</td> <td>3</td> </tr> <tr> <td>enumeration</td> <td>4</td> </tr> <tr> <td>enumeration</td> <td>5</td> </tr> <tr> <td>enumeration</td> <td>6</td> </tr> </tbody> </table>	Kind	Value	enumeration	1	enumeration	2	enumeration	3	enumeration	4	enumeration	5	enumeration	6
Kind	Value														
enumeration	1														
enumeration	2														
enumeration	3														
enumeration	4														
enumeration	5														
enumeration	6														

simpleType Tipo_Redito_Da1a8_Type

type	restriction of DatoNP_Type																		
facets	<table border="1"> <thead> <tr> <th>Kind</th> <th>Value</th> </tr> </thead> <tbody> <tr> <td>enumeration</td> <td>1</td> </tr> <tr> <td>enumeration</td> <td>2</td> </tr> <tr> <td>enumeration</td> <td>3</td> </tr> <tr> <td>enumeration</td> <td>4</td> </tr> <tr> <td>enumeration</td> <td>5</td> </tr> <tr> <td>enumeration</td> <td>6</td> </tr> <tr> <td>enumeration</td> <td>7</td> </tr> <tr> <td>enumeration</td> <td>8</td> </tr> </tbody> </table>	Kind	Value	enumeration	1	enumeration	2	enumeration	3	enumeration	4	enumeration	5	enumeration	6	enumeration	7	enumeration	8
Kind	Value																		
enumeration	1																		
enumeration	2																		
enumeration	3																		
enumeration	4																		
enumeration	5																		
enumeration	6																		
enumeration	7																		
enumeration	8																		

simpleType Tipo_Redito_Da1a9_Type

type	restriction of DatoNP_Type						
facets	<table border="1"> <thead> <tr> <th>Kind</th> <th>Value</th> </tr> </thead> <tbody> <tr> <td>enumeration</td> <td>1</td> </tr> <tr> <td>enumeration</td> <td>2</td> </tr> </tbody> </table>	Kind	Value	enumeration	1	enumeration	2
Kind	Value						
enumeration	1						
enumeration	2						

	enumeration 3
	enumeration 4
	enumeration 5
	enumeration 6
	enumeration 7
	enumeration 8
	enumeration 9

simpleType Titolo_Terreno_Type

type	restriction of DatoNP_Type	
facets	Kind	Value
	enumeration	1
	enumeration	2
	enumeration	3
	enumeration	4
	enumeration	5
	enumeration	6
	enumeration	7
	enumeration	10

simpleType Utilizzo_Fabbricato_Type

type	restriction of DatoNP_Type	
facets	Kind	Value
	enumeration	1
	enumeration	2
	enumeration	3
	enumeration	4
	enumeration	5
	enumeration	8
	enumeration	9
	enumeration	10
	enumeration	11
	enumeration	12
	enumeration	14
	enumeration	15
	enumeration	16
	enumeration	17

element ElencoFonti

diagram	<pre> classDiagram class ElencoFonti class p73_Fonte["p73:Fonte"] ElencoFonti "1" -- "*" p73_Fonte </pre>
type	p73:ElencoFontiType
children	p73:Fonte

element **Sintetico730**

diagram	<p>The diagram shows the 'Sintetico730' element (rectangle with a minus sign) connected to a sequence container (hexagon with three dots). This container is further divided into three parts: 'p73:DatiAnagrafici' (rectangle with a plus sign), 'p73:DataElaborazione' (rectangle with a plus sign), and 'p73:ElencoFonti' (rectangle with a plus sign, shown in a dashed box).</p>
children	p73:DatiAnagrafici p73:DataElaborazione p73:ElencoFonti

element **Sintetico730/DatiAnagrafici**

diagram	<p>The diagram shows the 'p73:DatiAnagrafici' element (rectangle with a minus sign) connected to a sequence container (hexagon with three dots), which is then connected to the 'p73:Anagrafica' element (rectangle with a plus sign). The entire sequence container and 'p73:Anagrafica' element are enclosed in a dashed yellow box labeled 'p73:DatiAnagraficiType'.</p>
type	p73:DatiAnagraficiType
children	p73:Anagrafica

element **Sintetico730/DataElaborazione**

diagram	<p>The diagram shows the 'p73:DataElaborazione' element (rectangle with a plus sign).</p>
type	p73:DataType

complexType **AnagraficaType**

diagram	<p>The diagram shows the 'AnagraficaType' element (rectangle with a minus sign) connected to a sequence container (hexagon with three dots). This container is further divided into three parts: 'p73:CodiceFiscale' (rectangle with a plus sign), 'p73:Nome' (rectangle with a plus sign), and 'p73:Cognome' (rectangle with a plus sign).</p>
children	p73:CodiceFiscale p73:Nome p73:Cognome

element **AnagraficaType/CodiceFiscale**

diagram	<p>The diagram shows the 'p73:CodiceFiscale' element (rectangle with a plus sign).</p>
type	xs:string

element **AnagraficaType/Nome**

diagram	
type	xs:string

element **AnagraficaType/Cognome**

diagram	
type	xs:string

complexType **DatiAnagraficiType**

diagram	
children	p73:Anagrafica

element **DatiAnagraficiType/Anagrafica**

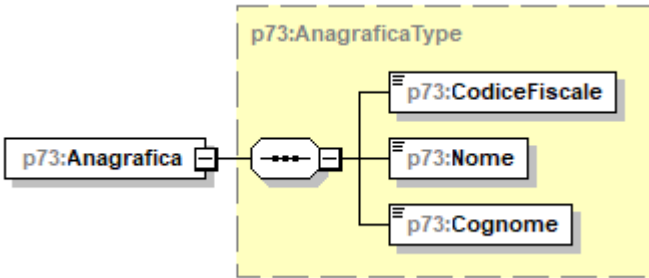
diagram	
type	p73:AnagraficaType
children	p73:CodiceFiscale p73:Nome p73:Cognome

complexType **DettaglioFonteType**

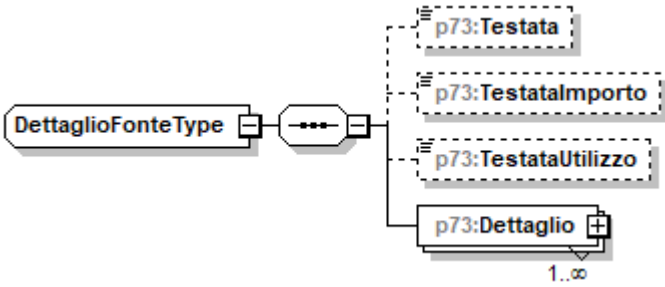
diagram	
children	p73:Testata p73:TestataImporto p73:TestataUtilizzo p73:Dettaglio

element **DettaglioFonteType/Testata**

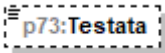
diagram	
type	xs:string

element **DettaglioFonteType/TestataImporto**

diagram	
type	xs:string

element **DettaglioFonteType/TestataUtilizzo**

diagram	
type	xs:string

element **DettaglioFonteType/Dettaglio**

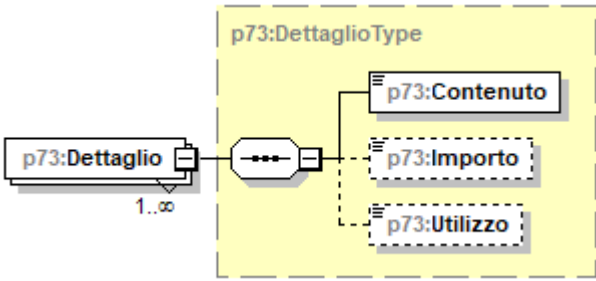
diagram	
type	p73:DettaglioType
children	p73:Contenuto p73:Importo p73:Utilizzo

complexType **DettaglioType**

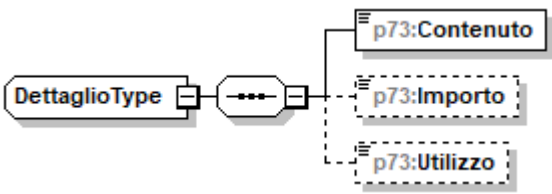
diagram	
children	p73:Contenuto p73:Importo p73:Utilizzo

element **DettaglioType/Contenuto**

diagram	
type	xs:string

element **DettaglioType/Importo**

diagram	
type	p73:ImportoType

element **DettaglioType/Utilizzo**

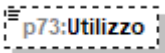
diagram	
type	xs:string

complexType **ElencoFontiType**

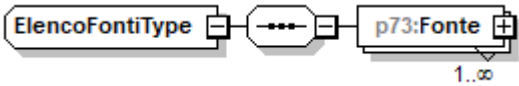
diagram	
children	p73:Fonte

element **ElencoFontiType/Fonte**

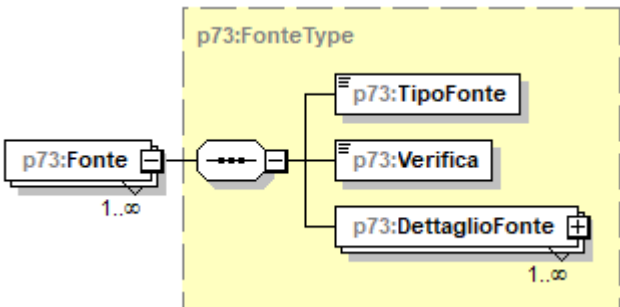
diagram	
type	p73:FonteType
children	p73:TipoFonte p73:Verifica p73:DettaglioFonte

complexType FonteType

diagram	
children	p73:TipoFonte p73:Verifica p73:DettaglioFonte

element FonteType/TipoFonte

diagram	
type	xs:string

element FonteType/Verifica

diagram	
type	xs:int

element FonteType/DettaglioFonte

diagram	
type	p73:DettaglioFonteType
children	p73:Testata p73:TestataImporto p73:TestataUtilizzo p73:Dettaglio

simpleType DataType

type	restriction of xs:string
------	--------------------------

simpleType ImportoType

type	restriction of xs:string
------	---------------------------------

simpleType DatoAN_Type

type	restriction of xs:string
------	---------------------------------

simpleType DatoCB12_Type

type	restriction of xs:byte
------	-------------------------------

simpleType DatoCB_Type

type	restriction of xs:byte
------	-------------------------------

simpleType DatoCF_Type

type	restriction of xs:string
------	---------------------------------

simpleType DatoCN_Type

type	restriction of xs:string
------	---------------------------------

simpleType DatoCP_Type

type	restriction of xs:string
------	---------------------------------

simpleType DatoD6_Type

type	restriction of xs:string
------	---------------------------------

simpleType DatoDA_Type

type	restriction of xs:string
------	---------------------------------

simpleType DatoDN_Type

type	restriction of xs:string
------	---------------------------------

simpleType DatoDT_Type

type	restriction of xs:string
------	---------------------------------

simpleType DatoEM_Type

type	restriction of xs:string
------	---------------------------------

simpleType DatoGA_Type

type	restriction of xs:string
------	---------------------------------

simpleType DatoN1_Type

type	restriction of xs:string
------	---------------------------------

simpleType DatoNP_Type

type	restriction of xs:string
------	---------------------------------

simpleType DatoNU_Type

type	restriction of xs:string
------	---------------------------------

simpleType DatoPC_Type

type	restriction of xs:string
------	---------------------------------

simpleType DatoPI_Type

type	restriction of xs:string
------	---------------------------------

simpleType DatoQU_Type

type	restriction of xs:string
------	---------------------------------

simpleType DatoTL_Type

type	restriction of xs:string
------	---------------------------------

simpleType DatoVP_Type

type	restriction of xs:string
------	---------------------------------

element Documento

diagram					
type	Documento_Type				
attributes	Name identificativo	Type Identificativo_Type	Use required	Default	Fixed

complexType Documento_Type

diagram					
attributes	Name identificativo	Type Identificativo_Type	Use required	Default	Fixed

attribute Documento_Type/@identificativo

type	Identificativo_Type
------	-------------------------------------

simpleType Identificativo_Type

type	restriction of <code>xs:string</code>
------	---------------------------------------

complexType Dati_Anagrafici_Type

diagram					
children	Cognome Nome Sesso DataNascita ComuneNascita ProvinciaNascita				

element Dati_Anagrafici_Type/Cognome

diagram	
type	DatoAN_Type

element Dati_Anagrafici_Type/Nome

diagram	
type	DatoAN_Type

element Dati_Anagrafici_Type/Sesso

diagram										
type	Sesso_Type									
facets	<table border="0"> <tr> <td>Kind</td> <td>enumeration</td> <td>Value</td> </tr> <tr> <td></td> <td>enumeration</td> <td>M</td> </tr> <tr> <td></td> <td>enumeration</td> <td>F</td> </tr> </table>	Kind	enumeration	Value		enumeration	M		enumeration	F
Kind	enumeration	Value								
	enumeration	M								
	enumeration	F								

element Dati_Anagrafici_Type/DataNascita

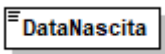
diagram	
type	DatoDT_Type

element Dati_Anagrafici_Type/ComuneNascita

diagram	
type	DatoAN_Type

element Dati_Anagrafici_Type/ProvinciaNascita

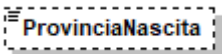
diagram	
type	PN_Type

complexType **Dati_Sottoscrittore_Type**

<p>diagram</p>	
<p>children</p>	<p>CodiceFiscale CodiceCarica CodiceFiscaleSocieta DatiAnagrafici ResidenzaEstera Telefono DataCarica InizioProcedura ProceduraNonTerminata FineProcedura</p>

element **Dati_Sottoscrittore_Type/CodiceFiscale**

<p>diagram</p>	
<p>type</p>	<p>DatoCF_Type</p>

element **Dati_Sottoscrittore_Type/CodiceCarica**

<p>diagram</p>																																	
<p>type</p>	<p>Codice Carica Type</p>																																
<p>facets</p>	<table border="1"> <thead> <tr> <th>Kind</th> <th>Value</th> </tr> </thead> <tbody> <tr><td>enumeration</td><td>1</td></tr> <tr><td>enumeration</td><td>2</td></tr> <tr><td>enumeration</td><td>3</td></tr> <tr><td>enumeration</td><td>4</td></tr> <tr><td>enumeration</td><td>5</td></tr> <tr><td>enumeration</td><td>6</td></tr> <tr><td>enumeration</td><td>7</td></tr> <tr><td>enumeration</td><td>8</td></tr> <tr><td>enumeration</td><td>9</td></tr> <tr><td>enumeration</td><td>10</td></tr> <tr><td>enumeration</td><td>11</td></tr> <tr><td>enumeration</td><td>12</td></tr> <tr><td>enumeration</td><td>13</td></tr> <tr><td>enumeration</td><td>14</td></tr> <tr><td>enumeration</td><td>15</td></tr> </tbody> </table>	Kind	Value	enumeration	1	enumeration	2	enumeration	3	enumeration	4	enumeration	5	enumeration	6	enumeration	7	enumeration	8	enumeration	9	enumeration	10	enumeration	11	enumeration	12	enumeration	13	enumeration	14	enumeration	15
Kind	Value																																
enumeration	1																																
enumeration	2																																
enumeration	3																																
enumeration	4																																
enumeration	5																																
enumeration	6																																
enumeration	7																																
enumeration	8																																
enumeration	9																																
enumeration	10																																
enumeration	11																																
enumeration	12																																
enumeration	13																																
enumeration	14																																
enumeration	15																																

element **Dati_Sottoscrittore_Type/CodiceFiscaleSocieta**

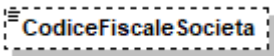
diagram	
type	DatoCN_Type

element **Dati_Sottoscrittore_Type/DatiAnagrafici**

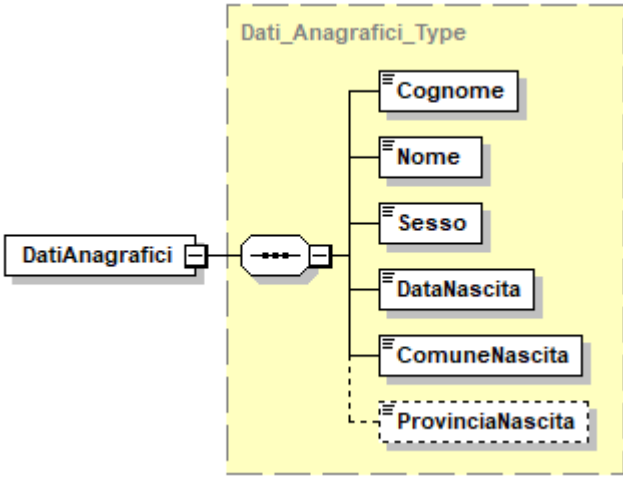
diagram	
type	Dati_Anagrafici_Type
children	Cognome Nome Sesso DataNascita ComuneNascita ProvinciaNascita

element **Dati_Sottoscrittore_Type/ResidenzaEstera**

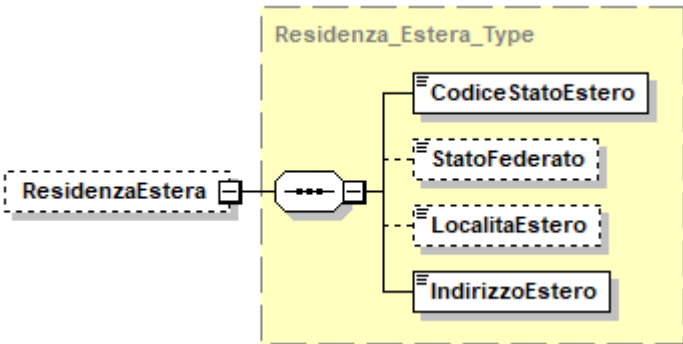
diagram	
type	Residenza_Estera_Type
children	CodiceStatoEstero StatoFederato LocalitaEstero IndirizzoEstero

element **Dati_Sottoscrittore_Type/Telefono**

diagram	
type	DatoTL_Type

element **Dati_Sottoscrittore_Type/DataCarica**

diagram	
type	DatoDT_Type

element **Dati_Sottoscrittore_Type/InizioProcedura**

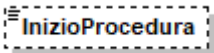
diagram	
type	DatoDT_Type

element **Dati_Sottoscrittore_Type/ProceduraNonTerminata**

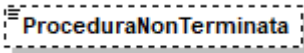
diagram	
type	DatoCB_Type

element **Dati_Sottoscrittore_Type/FineProcedura**

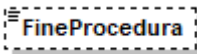
diagram	
type	DatoDT_Type

complexType **Domicilio_EE_Type**

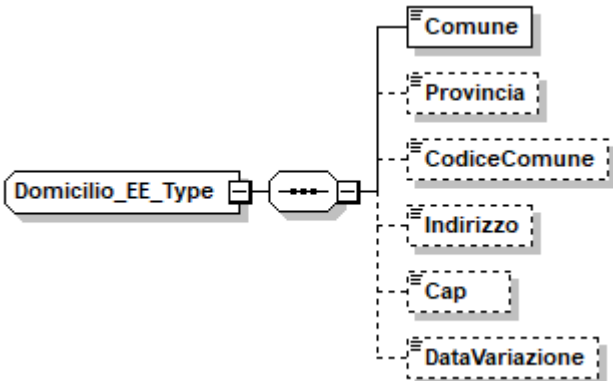
diagram	
---------	---

children	Comune Provincia CodiceComune Indirizzo Cap DataVariazione
----------	--

element **Domicilio_EE_Type/Comune**

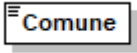
diagram	
type	DatoAN_Type

element **Domicilio_EE_Type/Provincia**

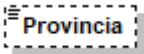
diagram	
type	PE_Type

element **Domicilio_EE_Type/CodiceComune**

diagram	
type	DatoAN_Type

element **Domicilio_EE_Type/Indirizzo**

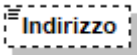
diagram	
type	DatoAN_Type

element **Domicilio_EE_Type/Cap**

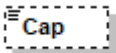
diagram	
type	DatoCP_Type

element **Domicilio_EE_Type/DataVariazione**

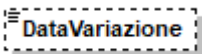
diagram	
type	DatoD6_Type

complexType Domicilio_Fiscale_Type

<p>diagram</p>	
<p>type</p>	<p>extension of Domicilio_Ita_Type</p>
<p>children</p>	<p>Comune Provincia CodiceComune Indirizzo Cap DataVariazione</p>

element Domicilio_Fiscale_Type/DataVariazione

<p>diagram</p>	
<p>type</p>	<p>DatoD6_Type</p>

complexType Domicilio_Ita_Type

<p>diagram</p>	
<p>children</p>	<p>Comune Provincia CodiceComune Indirizzo Cap</p>

element Domicilio_Ita_Type/Comune

<p>diagram</p>	
<p>type</p>	<p>DatoAN_Type</p>

element **Domicilio_Ita_Type/Provincia**

diagram	
type	PR_Type

element **Domicilio_Ita_Type/CodiceComune**

diagram	
type	DatoAN_Type

element **Domicilio_Ita_Type/Indirizzo**

diagram	
type	DatoAN_Type

element **Domicilio_Ita_Type/Cap**

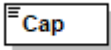
diagram	
type	DatoCP_Type

complexType **Firma_Revisione_Type**

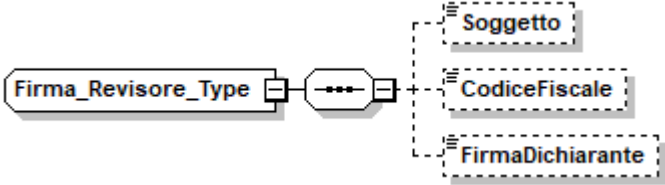
diagram	
children	Soggetto CodiceFiscale FirmaDichiarante

element **Firma_Revisione_Type/Soggetto**

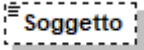
diagram	
type	restriction of DatoNP_Type

element **Firma_Revisore_Type/CodiceFiscale**

diagram	
type	DatoCF_Type

element **Firma_Revisore_Type/FirmaDichiarante**

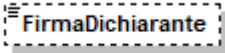
diagram	
type	DatoCB_Type

complexType **Firma_Type**

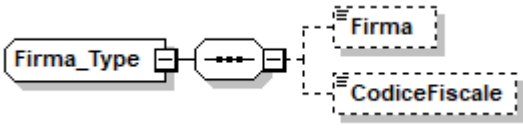
diagram	
children	Firma CodiceFiscale

element **Firma_Type/Firma**

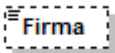
diagram	
type	DatoCB_Type

element **Firma_Type/CodiceFiscale**

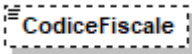
diagram	
type	restriction of xs:string

complexType **Frontespizio_Type**

diagram	
children	SoggettoFiscale

element **Frontespizio_Type/SoggettoFiscale**

diagram	
type	Soggetto_Fiscale_Type
children	CodiceFiscale Email Telefono Fax

complexType **Impegno_A_Trasmettere_Type**

diagram	
children	CFintermediario NumerolscrAlboCAF ImpegnoATrasmettere RicezioneAvvisoTelem DataImpegno FirmaIntermediario

element **Impegno_A_Trasmettere_Type/CFintermediario**

diagram	
type	DatoCF_Type

element **Impegno_A_Trasmettere_Type/NumerolscrAlboCAF**

diagram	
type	restriction of DatoNU_Type

element **Impegno_A_Trasmettere_Type/ImpegnoATrasmettere**

diagram							
type	restriction of DatoNP_Type						
facets	<table border="1"> <thead> <tr> <th>Kind</th> <th>Value</th> </tr> </thead> <tbody> <tr> <td>enumeration</td> <td>1</td> </tr> <tr> <td>enumeration</td> <td>2</td> </tr> </tbody> </table>	Kind	Value	enumeration	1	enumeration	2
Kind	Value						
enumeration	1						
enumeration	2						

element **Impegno_A_Trasmettere_Type/RicezioneAvvisoTelem**

diagram	
type	DatoCB_Type

element **Impegno_A_Trasmettere_Type/DatalImpegno**

diagram	
type	DatoDT_Type

element **Impegno_A_Trasmettere_Type/FirmaIntermediario**

diagram	
type	DatoCB_Type

complexType **Persone_Fisiche_Type**

diagram	
children	DatiAnagrafici ResidenzaAnagrafica

element **Persone_Fisiche_Type/DatiAnagrafici**

<p>diagram</p>	
<p>type</p>	<p>Dati_Anagrafici_Type</p>
<p>children</p>	<p>Cognome Nome Sesso DataNascita ComuneNascita ProvinciaNascita</p>

element **Persone_Fisiche_Type/ResidenzaAnagrafica**

<p>diagram</p>	
<p>type</p>	<p>Residenza_Anagrafica_Type</p>
<p>children</p>	<p>Comune Provincia CodiceComune Indirizzo Cap DataVariazione</p>

complexType **Residenza_Anagrafica_Type**

diagram	
type	extension of Domicilio_Ita_Type
children	Comune Provincia CodiceComune Indirizzo Cap DataVariazione

element **Residenza_Anagrafica_Type/DataVariazione**

diagram	
type	DatoDT_Type

complexType **Residenza_Estera_Type**

diagram	
children	CodiceStatoEstero StatoFederato LocalitaEstero IndirizzoEstero

element **Residenza_Estera_Type/CodiceStatoEstero**

diagram	
type	restriction of DatoAN_Type

element **Residenza_Estera_Type/StatoFederato**

diagram	
type	restriction of DatoAN_Type

element **Residenza_Estera_Type/LocalitaEstero**

diagram	
type	DatoAN_Type

element **Residenza_Estera_Type/IndirizzoEstero**

diagram	
type	DatoAN_Type

complexType **Soggetti_Diversi_Da_PF_Type**

diagram	
children	Denominazione SedeLegale DomicilioFiscale DataApprovazioneBilancio TermineApprovazioneBilancio InizioPeriodoImposta FinePeriodoImposta Stato NaturaGiuridica Situazione

element **Soggetti_Diversi_Da_PF_Type/Denominazione**

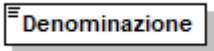
diagram	
type	DatoAN_Type

element **Soggetti_Diversi_Da_PF_Type/SedeLegale**

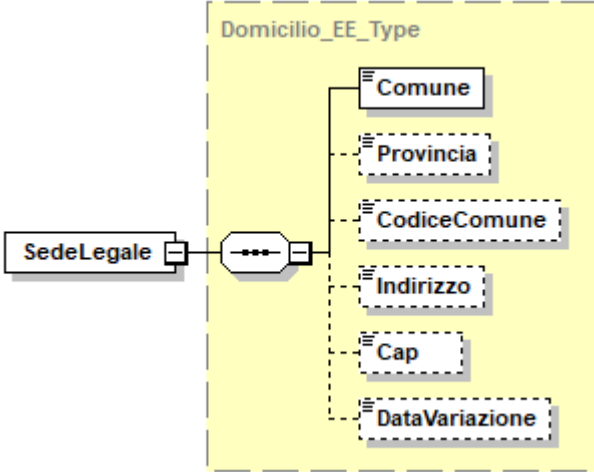
diagram	
type	Domicilio_EE_Type
children	Comune Provincia CodiceComune Indirizzo Cap DataVariazione

element **Soggetti_Diversi_Da_PF_Type/DomicilioFiscale**

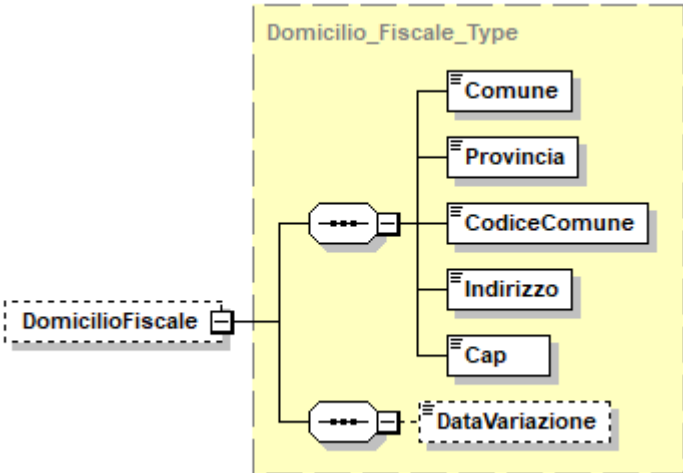
diagram	
type	Domicilio_Fiscale_Type
children	Comune Provincia CodiceComune Indirizzo Cap DataVariazione

element **Soggetti_Diversi_Da_PF_Type/DataApprovazioneBilancio**

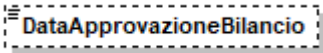
diagram	
type	DatoDT_Type

element **Soggetti_Diversi_Da_PF_Type/TermineApprovazioneBilancio**

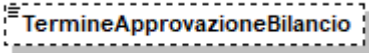
diagram	
type	DatoDT_Type

element **Soggetti_Diversi_Da_PF_Type/InizioPeriodoImposta**

diagram	
type	DatoDT_Type

element **Soggetti_Diversi_Da_PF_Type/FinePeriodoImposta**

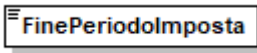
diagram	
type	DatoDT_Type

element **Soggetti_Diversi_Da_PF_Type/Stato**

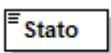
diagram											
type	Stato_Type										
facets	<table border="1"> <thead> <tr> <th>Kind</th> <th>Value</th> </tr> </thead> <tbody> <tr> <td>enumeration</td> <td>1</td> </tr> <tr> <td>enumeration</td> <td>2</td> </tr> <tr> <td>enumeration</td> <td>3</td> </tr> <tr> <td>enumeration</td> <td>4</td> </tr> </tbody> </table>	Kind	Value	enumeration	1	enumeration	2	enumeration	3	enumeration	4
Kind	Value										
enumeration	1										
enumeration	2										
enumeration	3										
enumeration	4										

element **Soggetti_Diversi_Da_PF_Type/NaturaGiuridica**

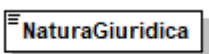
diagram															
type	Natura_Giuridica_Type														
facets	<table border="1"> <thead> <tr> <th>Kind</th> <th>Value</th> </tr> </thead> <tbody> <tr> <td>enumeration</td> <td>1</td> </tr> <tr> <td>enumeration</td> <td>2</td> </tr> <tr> <td>enumeration</td> <td>3</td> </tr> <tr> <td>enumeration</td> <td>4</td> </tr> <tr> <td>enumeration</td> <td>5</td> </tr> <tr> <td>enumeration</td> <td>6</td> </tr> </tbody> </table>	Kind	Value	enumeration	1	enumeration	2	enumeration	3	enumeration	4	enumeration	5	enumeration	6
Kind	Value														
enumeration	1														
enumeration	2														
enumeration	3														
enumeration	4														
enumeration	5														
enumeration	6														

enumeration	7
enumeration	8
enumeration	9
enumeration	10
enumeration	11
enumeration	12
enumeration	13
enumeration	14
enumeration	15
enumeration	16
enumeration	17
enumeration	18
enumeration	19
enumeration	20
enumeration	21
enumeration	22
enumeration	23
enumeration	24
enumeration	25
enumeration	26
enumeration	27
enumeration	28
enumeration	29
enumeration	30
enumeration	31
enumeration	32
enumeration	33
enumeration	34
enumeration	35
enumeration	36
enumeration	37
enumeration	38
enumeration	39
enumeration	40
enumeration	41
enumeration	42
enumeration	43
enumeration	44
enumeration	45
enumeration	50
enumeration	51
enumeration	52
enumeration	53
enumeration	54
enumeration	55
enumeration	56
enumeration	57
enumeration	58
enumeration	59

element **Soggetti_Diversi_Da_PF_Type/Situazione**

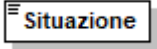
diagram		
type	Situazione_Type	
facets	Kind	Value
	enumeration	1
	enumeration	2
	enumeration	3
	enumeration	4
	enumeration	5
	enumeration	6
	enumeration	7

complexType **Soggetti_Non_Residenti_Type**

diagram	
children	StatoEsteroResidenza CodiceStatoEstero CodicelIdentificazioneEstero

element **Soggetti_Non_Residenti_Type/StatoEsteroResidenza**

diagram	
type	DatoAN_Type

element **Soggetti_Non_Residenti_Type/CodiceStatoEstero**

diagram	
type	DatoAN_Type

element **Soggetti_Non_Residenti_Type/CodicelIdentificazioneEstero**

diagram	
type	DatoAN_Type

complexType **Soggetto_Fiscale_Type**

diagram	
children	CodiceFiscale Email Telefono Fax

element **Soggetto_Fiscale_Type/CodiceFiscale**

diagram	
type	DatoCF_Type

element **Soggetto_Fiscale_Type/Email**

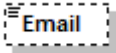
diagram	
type	DatoEM_Type

element **Soggetto_Fiscale_Type/Telefono**

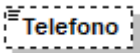
diagram	
type	DatoTL_Type

element **Soggetto_Fiscale_Type/Fax**

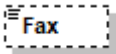
diagram	
type	DatoTL_Type

complexType **Tipo_Dichiarazione_Type**

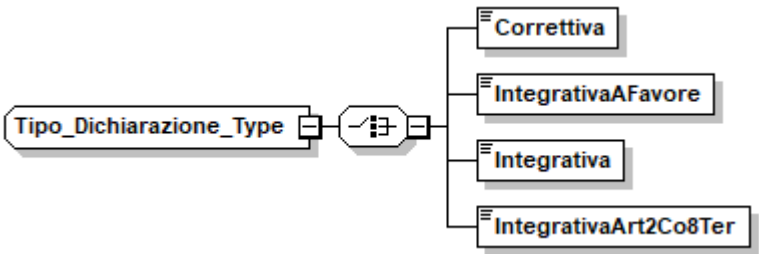
diagram	
children	Correttiva IntegrativaAFavore Integrativa IntegrativaArt2Co8Ter

element **Tipo_Dichiarazione_Type/Correttiva**

diagram	
type	DatoCB_Type

element **Tipo_Dichiarazione_Type/IntegrativaAFavore**

diagram	
type	DatoCB_Type

element **Tipo_Dichiarazione_Type/Integrativa**

diagram	
type	DatoCB_Type

element **Tipo_Dichiarazione_Type/IntegrativaArt2Co8Ter**

diagram	
type	DatoCB_Type

complexType **Visto_Conformita_Type**

diagram	
children	VistoCAF CFprofessionista Firma

element **Visto_Conformita_Type/VistoCAF**

diagram	
children	CFResp CF_CAF

element **Visto_Conformita_Type/VistoCAF/CFResp**

diagram	
type	DatoCF_Type

element **Visto_Conformita_Type/VistoCAF/CF_CAF**

diagram	
type	DatoCN_Type

element **Visto_Conformita_Type/CFprofessionista**

diagram	
type	DatoCF_Type

element **Visto_Conformita_Type/Firma**

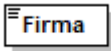
diagram	
type	DatoCB_Type

simpleType **Estero**

type	restriction of xs:string				
facets	<table border="1"> <thead> <tr> <th>Kind</th> <th>Value</th> </tr> </thead> <tbody> <tr> <td>enumeration</td> <td>EE</td> </tr> </tbody> </table>	Kind	Value	enumeration	EE
Kind	Value				
enumeration	EE				

simpleType **PE_Type**

type	union of (ProvinciItaliane , Estero)
------	--

simpleType **PN_Type**

type	union of (ProvinciItaliane , ProvincieCroate , Estero , ProvincieSoppresse)
------	---

simpleType **PR_Type**

type	union of (ProvinciItaliane)
------	---

simpleType **ProvincieCroate**

type	restriction of xs:string								
facets	<table border="1"> <thead> <tr> <th>Kind</th> <th>Value</th> </tr> </thead> <tbody> <tr> <td>enumeration</td> <td>FU</td> </tr> <tr> <td>enumeration</td> <td>PL</td> </tr> <tr> <td>enumeration</td> <td>ZA</td> </tr> </tbody> </table>	Kind	Value	enumeration	FU	enumeration	PL	enumeration	ZA
Kind	Value								
enumeration	FU								
enumeration	PL								
enumeration	ZA								

simpleType **ProvinciItaliane**

type	restriction of xs:string	
facets	Kind	Value
	enumeration	AG
	enumeration	AL
	enumeration	AN
	enumeration	AO
	enumeration	AP
	enumeration	AQ
	enumeration	AR
	enumeration	AT
	enumeration	AV
	enumeration	BA
	enumeration	BG
	enumeration	BI
	enumeration	BL
	enumeration	BN
	enumeration	BO
	enumeration	BR
	enumeration	BS
	enumeration	BT
	enumeration	BZ
	enumeration	CA
	enumeration	CB
	enumeration	CE
	enumeration	CH
	enumeration	CI
	enumeration	CL
	enumeration	CN
	enumeration	CO
	enumeration	CR
	enumeration	CS
	enumeration	CT
	enumeration	CZ
	enumeration	EN
	enumeration	FC
	enumeration	FE
	enumeration	FG
	enumeration	FI
	enumeration	FM
	enumeration	FR
	enumeration	GE
	enumeration	GO
	enumeration	GR
	enumeration	IM
	enumeration	IS
	enumeration	KR
	enumeration	LC
	enumeration	LE
	enumeration	LI
	enumeration	LO
	enumeration	LT
	enumeration	LU
	enumeration	MB
	enumeration	MC
	enumeration	ME
	enumeration	MI
	enumeration	MN
	enumeration	MO
	enumeration	MS
	enumeration	MT
	enumeration	NA
	enumeration	NO
	enumeration	NU
	enumeration	OG
	enumeration	OR
	enumeration	OT
	enumeration	PA

enumeration	PC
enumeration	PD
enumeration	PE
enumeration	PG
enumeration	PI
enumeration	PN
enumeration	PO
enumeration	PR
enumeration	PT
enumeration	PU
enumeration	PV
enumeration	PZ
enumeration	RA
enumeration	RC
enumeration	RE
enumeration	RG
enumeration	RI
enumeration	RM
enumeration	RN
enumeration	RO
enumeration	SA
enumeration	SI
enumeration	SO
enumeration	SP
enumeration	SR
enumeration	SS
enumeration	SU
enumeration	SV
enumeration	TA
enumeration	TE
enumeration	TN
enumeration	TO
enumeration	TP
enumeration	TR
enumeration	TS
enumeration	TV
enumeration	UD
enumeration	VA
enumeration	VB
enumeration	VC
enumeration	VE
enumeration	VI
enumeration	VR
enumeration	VS
enumeration	VT
enumeration	VV

simpleType ProvincieSoppresse

type	restriction of xs:string	
facets	Kind	Value
	enumeration	FO
	enumeration	PS

simpleType Casella_Quadro_Type

type	restriction of DatoAN_Type	
facets	Kind	Value
	enumeration	0
	enumeration	1
	enumeration	2
	enumeration	3

simpleType Codice_Carica_Type

type	restriction of DatoNP_Type	
facets	Kind	Value
	enumeration	1
	enumeration	2
	enumeration	3
	enumeration	4
	enumeration	5
	enumeration	6
	enumeration	7
	enumeration	8
	enumeration	9
	enumeration	10
	enumeration	11
	enumeration	12
	enumeration	13
	enumeration	14
	enumeration	15

simpleType Codice_Regione_Type

type	restriction of DatoAN_Type	
facets	Kind	Value
	enumeration	1
	enumeration	2
	enumeration	3
	enumeration	4
	enumeration	5
	enumeration	6
	enumeration	7
	enumeration	8
	enumeration	9
	enumeration	10
	enumeration	11
	enumeration	12
	enumeration	13
	enumeration	14
	enumeration	15
	enumeration	16
	enumeration	17
	enumeration	18
	enumeration	19
	enumeration	20
	enumeration	21

simpleType Natura_Giuridica_Type

type	restriction of DatoNP_Type	
facets	Kind	Value
	enumeration	1
	enumeration	2
	enumeration	3
	enumeration	4
	enumeration	5
	enumeration	6
	enumeration	7
	enumeration	8
	enumeration	9
	enumeration	10
	enumeration	11
	enumeration	12
	enumeration	13

enumeration	14
enumeration	15
enumeration	16
enumeration	17
enumeration	18
enumeration	19
enumeration	20
enumeration	21
enumeration	22
enumeration	23
enumeration	24
enumeration	25
enumeration	26
enumeration	27
enumeration	28
enumeration	29
enumeration	30
enumeration	31
enumeration	32
enumeration	33
enumeration	34
enumeration	35
enumeration	36
enumeration	37
enumeration	38
enumeration	39
enumeration	40
enumeration	41
enumeration	42
enumeration	43
enumeration	44
enumeration	45
enumeration	50
enumeration	51
enumeration	52
enumeration	53
enumeration	54
enumeration	55
enumeration	56
enumeration	57
enumeration	58
enumeration	59

simpleType Sesso_Type

type	restriction of DatoAN_Type	
facets	Kind	Value
	enumeration	M
	enumeration	F

simpleType Situazione_Type

type	restriction of DatoNP_Type	
facets	Kind	Value
	enumeration	1
	enumeration	2
	enumeration	3
	enumeration	4
	enumeration	5
	enumeration	6
	enumeration	7

simpleType Stato_Type

type	restriction of DatoNP_Type	
facets	Kind	Value
	enumeration	1
	enumeration	2
	enumeration	3
	enumeration	4

simpleType Eventi_Ecc_Type

type	restriction of xs:string	
facets	Kind	Value
	enumeration	1
	enumeration	2
	enumeration	3
	enumeration	4

DESCRIZIONE DEI CODICI PRESENTI NELLA FORNITURA P7323, RELATIVI ALL'ESITO DELLA RICHIESTA DI MOD. 730 PRECOMPILATI TRAMITE FILE	
MODELLO 730 PRECOMPILATO PRESENTE NELLA FORNITURA P7323	
Valori dell'elemento "stato" presente in "EsitoRichiesta" del file xml di fornitura P7323	Descrizione
300	Per il codice fiscale del contribuente è presente il 730 Precompilato con il relativo prospetto di liquidazione
310	Per il codice fiscale del contribuente è presente il 730 Precompilato ma non è liquidabile
320	Per il codice fiscale del contribuente è presente il 730 Precompilato con il relativo prospetto di liquidazione. La dichiarazione precompilata è relativa ad un soggetto deceduto
330	Per il codice fiscale del contribuente è presente il 730 Precompilato ma non è liquidabile. La dichiarazione precompilata è relativa ad un soggetto deceduto
MODELLO 730 PRECOMPILATO NON PRESENTE NELLA FORNITURA P7323	
Valori dell'elemento "stato" presente in "EsitoRichiesta" del file xml di fornitura P7323	Descrizione
055, 355	Il codice fiscale del contribuente non è valido
056	Il codice fiscale del contribuente non è associato ad una persona fisica
057, 357	Il codice fiscale del contribuente non è utilizzabile in quanto aggiornato in altro codice fiscale (*)
064, 065	Per il codice fiscale del contribuente non risulta presentata alcuna dichiarazione 730/2022 o Redditi PF/2022 congruente con gli importi indicati nella richiesta
066	Per il codice fiscale del contribuente risulta presentata una dichiarazione 730/2022 o Redditi PF/2022 e risulta compilato il flag "Assenza di dichiarazione presentata "
067	Per il codice fiscale del contribuente il 730 Precompilato è in corso di elaborazione
307	Per il codice fiscale del contribuente non è stato predisposto il 730 Precompilato
308, 311	Per il codice fiscale del contribuente il 730 Precompilato non è disponibile. Per le motivazioni consultare il sito di Assistenza https://assistenza.agenziaentrate.gov.it
058	Per il codice fiscale del contribuente il 730 Precompilato non è disponibile in quanto per il codice fiscale del contribuente non risulta trasmessa nei termini, dal sostituto d'imposta (soggetto richiedente) all'Agenzia delle entrate, la Certificazione Unica 2023 per redditi di lavoro dipendente

068	Per il codice fiscale del contribuente il 730 Precompilato non è disponibile in quanto il soggetto richiedente non ha una delega valida a richiederlo
Nota (*) Il codice fiscale indicato non è utilizzabile perché è un cosiddetto “omocodice”, cioè corrispondente ai dati anagrafici di diverse persone. L’Agenzia delle Entrate ha quindi attribuito un nuovo codice fiscale, differente, a ciascuna di esse. Il nuovo codice fiscale è stato comunicato alle persone interessate ed è quello che va utilizzato.	

La situazione in cui ad una stessa descrizione corrispondono due distinti codici, nella generalità dei casi, fa riferimento ai diversi momenti nei quali è stata riscontrata l’anomalia (acquisizione della richiesta ovvero predisposizione della fornitura).